

Freight Elevator

Model LF-II

HITACHI
Inspire the Next

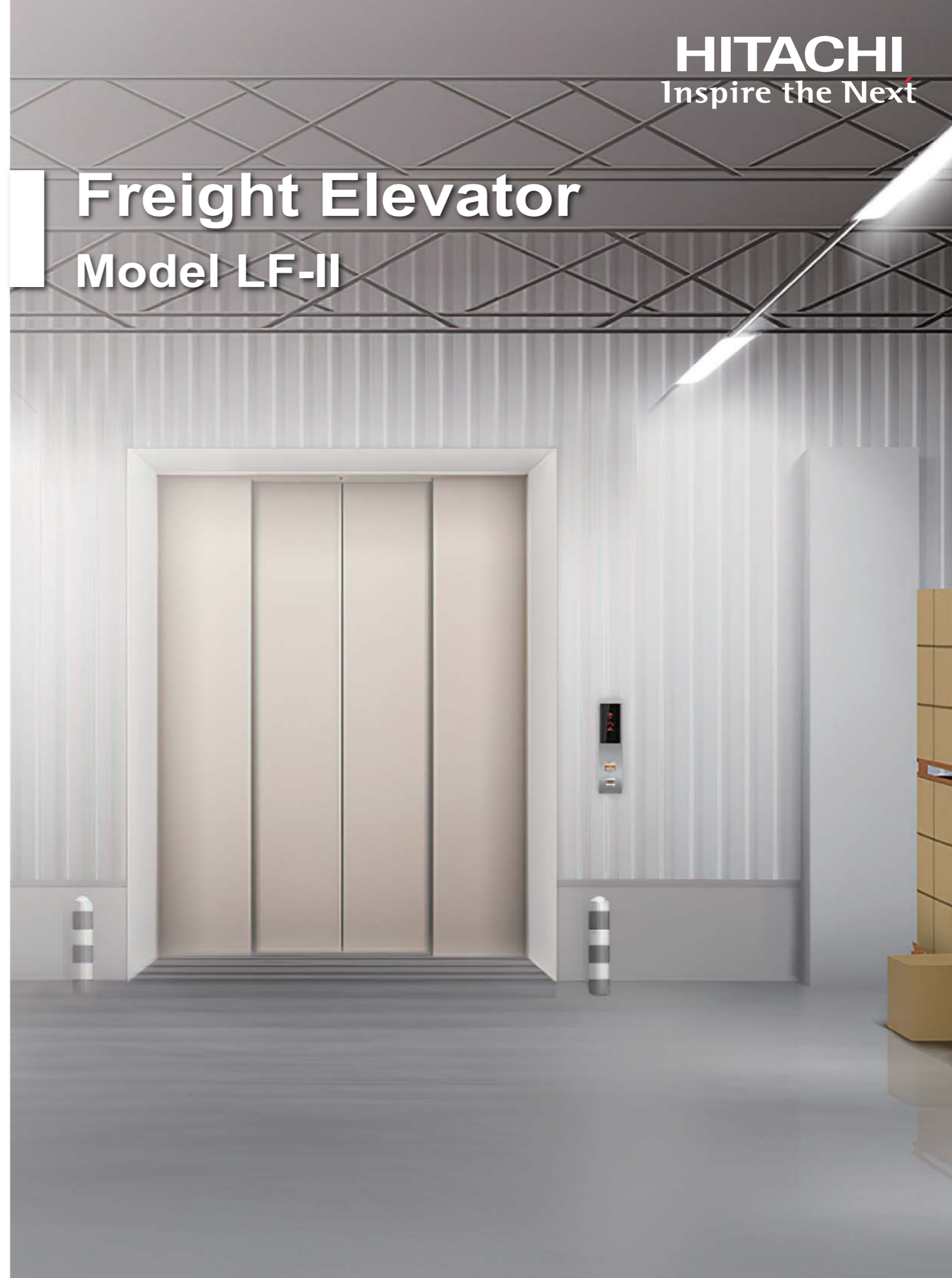

With the emergence of new scenarios and applications driven by a new technological revolution, the industrial design community is embracing new ways of thinking and creating. Given these trends, Hitachi Elevator is seeking to apply a diverse lineup of technologies to industrial design, with the aim of better meeting customers need.

CONTENTS

01 / Optimized Design

03 / Precise Control System

05 / Humanised Design

07 / Car Design

13 / Specification



Optimized Design

Empowering elevators with the improved hoistway design and roping system to make the elevator more suitable for the buildings. Various decorations and option specification based on customer's need are available to meet the particular requirements.



Optimized Machine Room Space

Through updating the traction system and components to improve the utilization of machine room space.

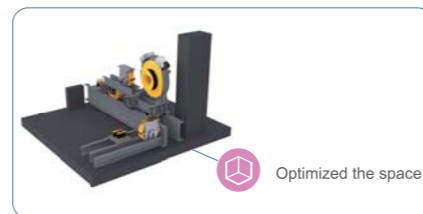

Permanent Magnet Synchronous

The new permanent magnet synchronous traction machine is compact in size, lighter in weight, with lower energy consumption and higher braking torque to meet the duty for heavy capacity.

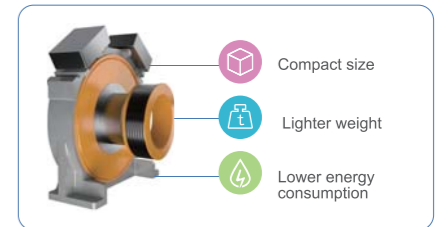

Hydraulic Buffer

The hydraulic buffer is durable with simple maintenance features. Furthermore, its standard metal base helps to enhance the installation efficiency.

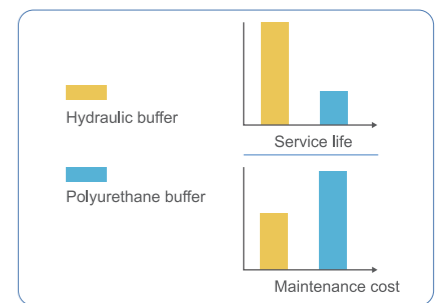

Anti-collision Protection (Option)

Anti-collision protection is an option feature, to mitigate the collision impact on the car walls.



Counterweight Safety Gear (Option)

With counterweight safety gear, hanging pit layout complying to GB standards can be achieved.

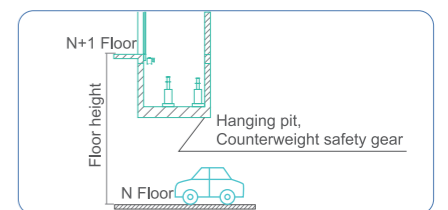

Precise Control System

With the ongoing commitment to improve our product, through the optimization of control system, fluent operation of the freight elevator is realized.

High Precision Starting Torque Compensation

- ◇ Accurate rotation coder helps to achieve a smooth and comfortable start.
- ◇ Improved system and components setting to enhance stability and reduce noise.

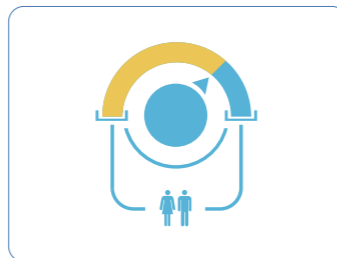

High Performance Processor

- ◇ Compact size multi-processor system with faster calculation speed.
- ◇ Advanced digital processing capability to improve efficiency and energy saving.
- ◇ High performance microcomputer that control the frequency conversion to ensure accurate and reliable control.

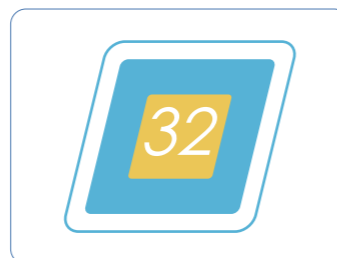

Serial Communication

- ◇ The high grade serial communication offer superior anti-interference level, high calculation speed and short communication distance features to improve the accuracy and speed of signal transmission.

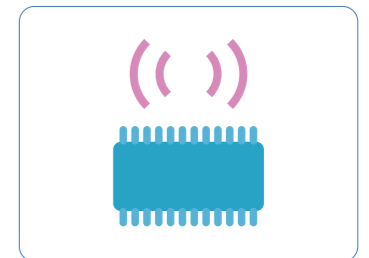

Stepless Speed Control

- ◇ Hitachi elevator has been adopting stepless speed control for many years. With Hitachi's highly efficient control system, the precise optimum traveling speed curve can be directly calculated by the output according to the distance from the car location to the destination.

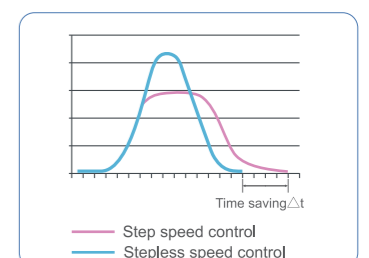

Humanised Design

We strive to deliver a more convenient and safer experience for the transportation of cargo with series of standard and exclusive functions.



Door Opening Prolong Function

◇ In Car

With the standard door opening prolong button in car, users do not need to push the button for long period of time during loading and unloading.

◇ In Hall

Door opening prolong button in hall is also a standard function. Users do not need to push the button for long period of time or enter the car to push the prolong button. This enhances the efficiency and safety during loading and unloading.

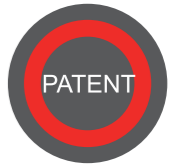

Manual Re-leveling Function (Option)

◇ When there is difference in the level between car floor and landing floor caused by the weight of the cargo, this function allows the user to manually adjust the level so that loading and unloading of cargo can be carried out smoothly.

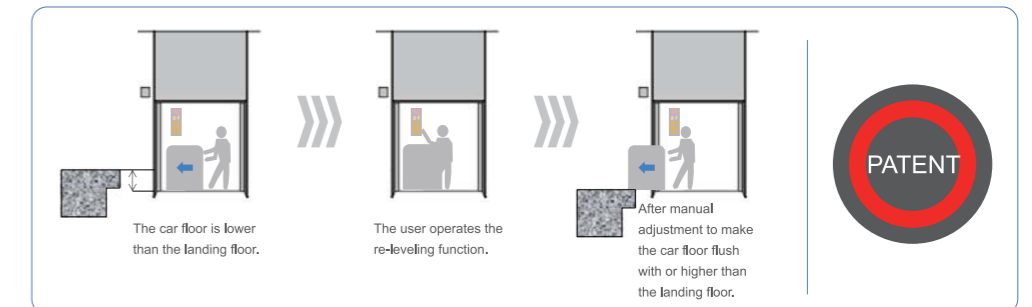

Multi-Beam Protection

◇ Multi-beam protection is a standard function configured to provide contact-less protection for the users and cargo.

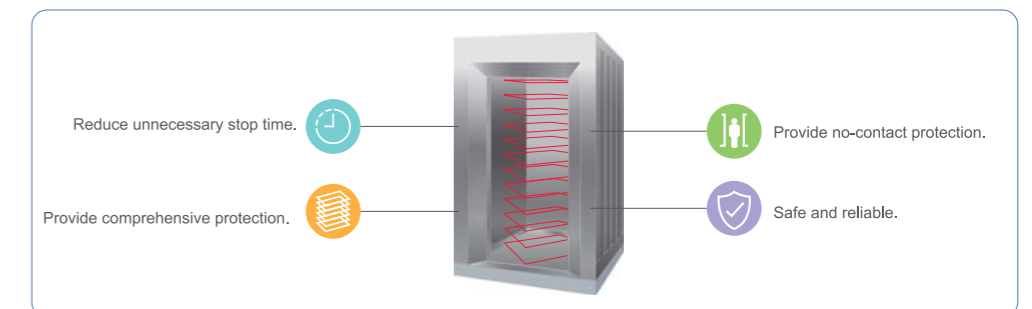

Car Design



Standard

Car ceiling: Painted steel
 HP57 (Matt light brown)
 Lighting: LED downlight
 Ventilation: Circular fan
 Car wall: Painted steel
 HP57 (Matt light brown)
 Car door: Painted steel
 HP57 (Matt light brown)
 Floor: Checkered steel plate



Option

Car ceiling: Stainless steel hairline
 Lighting: LED downlight
 Ventilation: Circular fan
 Car floor: Stainless steel hairline
 Car door: Stainless steel hairline
 Floor: Checkered steel plate
 Anti-collision on 3 Sides:
 Stainless steel hairline
 (With or Without)



Option

Anti-collision on 3 Sides:
 Stainless steel hairline



Option

Car ceiling: Painted steel
 CP30 (Light cyan)
 Lighting: LED downlight
 Ventilation: Circular fan
 Car wall: Painted steel
 CP30 (Light cyan)
 Car door: Painted steel
 CP30 (Light cyan)
 Floor: Checkered steel plate
 Anti-collision on 3 Sides:
 Stainless steel hairline
 (With or Without)

Operating Panel and Entrance

Car Operating Panel

Standard



GOP-195
 Indicator: Dot-matrix
 Button: GL-MOA
 Finishes: Stainless steel hairline

Option



GOP-196
 Indicator: Monochrome LCD
 Button: GL-MW
 Finishes: Stainless steel hairline

Hall Operating Panel (Surface-mount Type)

Standard



VIB-658 VIB-658W
 Indicator: Dot-matrix
 Button: GL-MOA
 Finishes: Stainless steel hairline

Option



VIB-668 VIB-668W
 Indicator: Monochrome LCD
 Button: GL-MW
 Finishes: Stainless steel hairline

Button

Standard



GL-MOA

Option



GL-MW

Entrance

Standard



AS-1X
 Opening type: 2S-2P
 Jamb frame: Painted steel HP57 (Matt light brown)
 Door panel: Painted steel HP57 (Matt light brown)
 Door sill: Extruded hard aluminum

Option



AS-1X
 Opening type: 2S-2P
 Jamb frame: Stainless steel hairline
 Door panel: Stainless steel hairline
 Door sill: Extruded hard aluminum

Option



AS-1X
 Opening type: 2S-2P
 Jamb frame: Painted steel CP30 (Light cyan)
 Door panel: Painted steel CP30 (Light cyan)
 Door sill: Extruded hard aluminum

Standard



AS-1X
 Opening type: 4P-CO
 Jamb frame: Painted steel HP57 (Matt light brown)
 Door panel: Painted steel HP57 (Matt light brown)
 Door sill: Extruded hard aluminum

Option



AS-1X
 Opening type: 4P-CO
 Jamb frame: Stainless steel hairline
 Door panel: Stainless steel hairline
 Door sill: Extruded hard aluminum

Option



AS-1X
 Opening type: 4P-CO
 Jamb frame: Painted steel CP30 (Light cyan)
 Door panel: Painted steel CP30 (Light cyan)
 Door sill: Extruded hard aluminum

Decoration & Entrance

Car Decoration

Item	Specification	● Standard	○ Option
Ceiling	Painted steel HP57 (Matt Light Brown)	●	
	Painted steel WN01 (Ivory White) / CP30 (Light Cyan)		○
	Stainless steel hairline		○
Car Door/Transom/ Front Return Wall	Painted steel HP57 (Matt Light Brown)	●	
	Painted steel WN01 (Ivory White) / CP30 (Light Cyan)		○
	Stainless steel hairline		○
3 Side Walls	Painted steel HP57 (Matt Light Brown)	●	
	Painted steel WN01 (Ivory White) / CP30 (Light Cyan)		○
	Stainless steel hairline		○
Anti-collision Protection	Stainless steel hairline		○
Car Sill	Extruded hard aluminum [One-time loading: ≤500kg]	●	
	Mild steel [One-time loading: ≤1200kg (Load 1600~2000kg), ≤1800kg (Load 3000kg)]		○
Car Floor	Checkered steel plate	●	
Car Operating Panel	GOP-195	●	
	GOP-196		○

Entrance

Item	Specification	● Standard	○ Option
Jamb Type	AS-1X, Jamb width=100mm	●	
	RS-1, Jamb width=100mm		○
	SS-1X, Jamb width≤300mm		○
	TS-1X, Jamb width≤300mm		○
Jamb Finish	Painted steel HP57 (Matt Light Brown)	●	
	Painted steel WN01 (Ivory White) / CP30 (Light Cyan)		○
	Stainless steel hairline		○
Landing Door	Painted steel HP57 (Matt Light Brown)	●	
	Painted steel WN01 (Ivory White) / CP30 (Light Cyan)		○
	Stainless steel hairline		○
Landing Sill	Extruded hard aluminum [One-time loading: ≤500kg]	●	
	Mild steel [One-time loading: ≤1200kg (Load 1600~2000kg), ≤1800kg (Load 3000kg)]		○
Hall Operating Panel	Surface-mount type: VIB-658 / VIB-658W	●	
	Surface-mount type: VIB-668 / VIB-668W		○

Buttons

Item	Specification	● Standard	○ Option
Button	GL-MOA	●	
	GL-MW		○

Elevator Function

Standard Function

Control System			
SA1	Simplex	SA2	Floor Height Self Measurement
SA3	On-Cage (Car Top) Maintenance Operation	SA4	In-Cage Maintenance Operation
SA5	Overspeed Electrical Protection	SA6	Overspeed Mechanical Protection
SA7	Rope Slipping Running Protection	SA8	Motor Thermal Protection
SA9	Nearest Landing Operation	SA10	Automatic Fault Detection
SA11	Automatic Fault Recording	SA12	Standby Regular Auto-Check
SA13	Overload Detection System	SA14	Overload Alarm
SA15	Lift-Position Abnormity Auto-Correction Function	SA16	Double Brake-Safety Check Operation
SA17	Synchronous Motor Magnetic Pole Static Test	SA18	Machine Room Debugging Operation Function
Safe Communication and Riding			
SB1	Interphone System (5 ways)	SB2	Out of Door-Open Zone Alarm
SB3	Alarm System	SB4	Full Load Bypass Operation
SB5	Door Opening / Closing Time Abnormity Protection	SB6	Next Drive (Door Open Abnormity)
SB7	Automatic Door Dwell Time Adjustment	SB8	Automatic Door Dwell Time Control
SB9	Number of runs Indicator		
Emergency Solution			
SC1	Car Emergency Lighting	SC2	Fire Emergency Operation (Automatic)
Design for Comfort			
SD1	Parking Operation	SD2	Automatic Return Function
SD3	Start Torque Auto-Adjustment	SD4	Door-Stop Function (Maintenance)
SD5	Micro Levelling (Travel≥20m)	SD6	Independent Operation
SD7	Car Light Auto Turn-Off	SD8	Car Fan Auto Turn-off
SD9	Opposite Direction Car Call Cancellation	SD10	Door-Opening Prolong Function in Car
SD11	Door-Opening Prolong Function in Hall	SD12	Maintenance Display Function
SD13	Stepless Speed Control	SD14	Multi-beam Protection
SD15	Overload Indicator (In Car)		

Optional Function

Control System			
OA1	Simplex Down Collective Control	OA2	Duplex Collective Control
OA3	Duplex Down Collective Control		
Safe Communication and Riding			
OB1	Contact at Control Panel (RS485)	OB2	Contact at Control Panel (Dry Contact)
OB3	Elevator Monitoring System (Computer Type)	OB4	Supervisory Panel (Dry Contact Type)
OB5	Twisted Pair Cable (1 pair) for CCTV	OB6	Card Reader Interfacing (In Car) (RS485) (Not applicable when OD2 is selected)
OB7	Twisted Pair Cable (1 pair) for BGM	OB8	Camera Device Inside the Car
Emergency Solution			
OC1	Automatic Rescue Device (Maximum travel distance ≤ 30m)	OC2	Earthquake Emergency Operation
OC3	EM. Operation for Power Failure (Manual)	OC4	EM. Operation for Power Failure (Auto)
OC5	Pit Flood Operation		
Design for Comfort			
OD1	Attendant Operation	OD2	Floor Lock Out Operation (Not applicable when OB6 is selected)
OD3	Hall Call Registration in Car Operating panel (Applicable when OD1 is selected)	OD4	Inspection Indication in Hall Indicator
OD5	Voice Synthesizer	OD6	Arrival Chime (Car Top & Bottom)
OD7	Multi-Beam + Safety Edge Protection	OD8	Car Indicator Signal Lamp
OD9	Double Opening Function	OD10	Car Call Deselect Function
OD11	Advance Door Opening	OD12	Manual Re-Leveling Function
OD13	Micro Levelling (Travel<20m)		

Hoistway and Machine Room

Hoistway and Machine Room

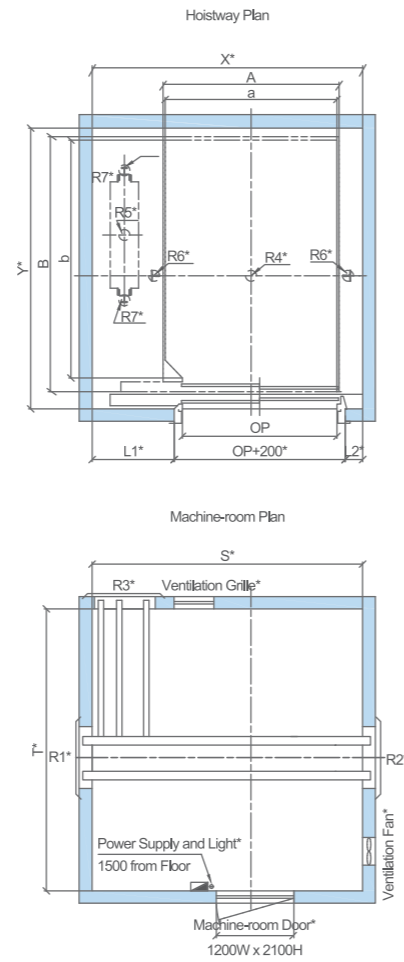
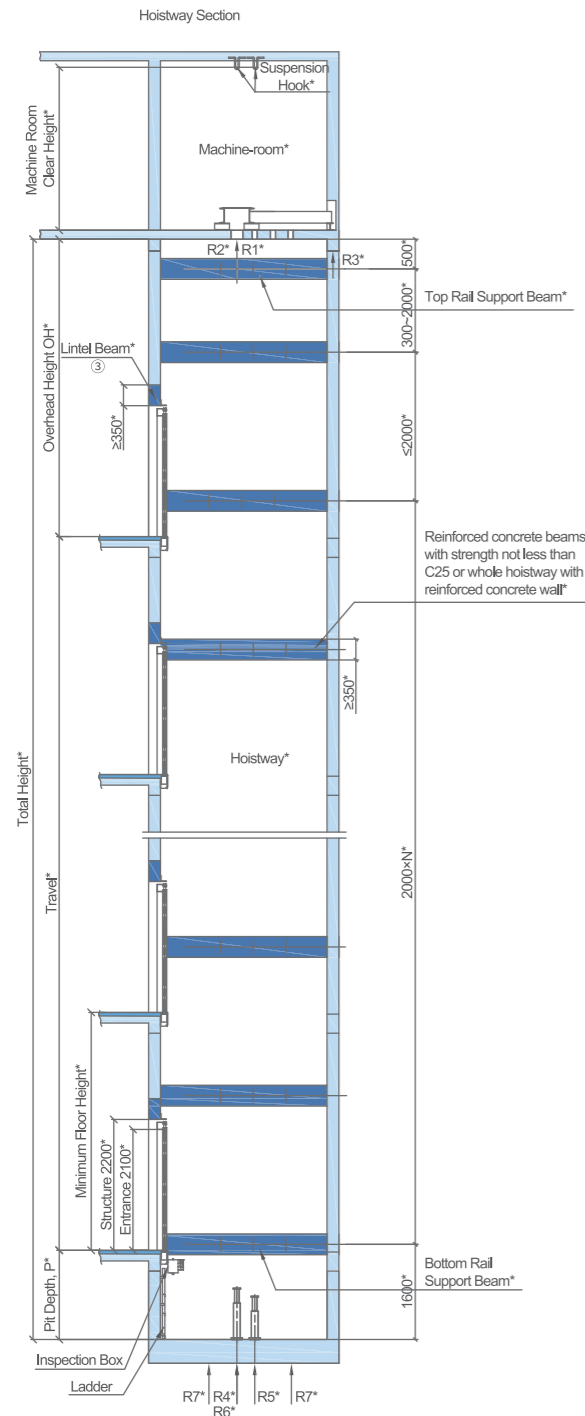

Note:

- ① Items with "*" shall be furnished by building contractors.
- ② Hoistway shall not be located next to bedrooms, classroom, ward, library or any other places where low noise is required.
- ③ The hoistway construction shall be reinforced concrete ring beam with strength C25 or whole hoistway of reinforced concrete wall. If you have other situations, please contact us.
- ④ For hoistway and machine room details, please contact us.
- ⑤ Unit of dimension shall be in mm unless otherwise stated.

Load (kg)	Speed (m/min)	Machine Room Clear Height (mm)	Number of Suspension Hooks (Per lift)	Suspension Hook Capacity (Tons)
1600	30/60	2500	3	3
2000	30/60	2500	3	4
3000	30/60	2500	3	5

Load (kg)	Speed (m/min)	Car Size (mm)		Door Opening (mm)		Front Wall Arrangement (mm)		Hoistway (mm) X×Y	Machine Room (mm) S×T	Reaction Loading (KN)						
		Internal (a×b)	External (A×B)	Type	Width (OP)	L1	L2			Machine Room			Pit			
										R1	R2	R3	R4	R5	R6	R7
1600 (Single Opening)	30	1600×2100	1650×2300	2S-2P	1500	800	200	2700×2600	2700×2600	90	70	20	170	140	55	5
	60															
2000 (Single Opening)	30	1600×2500	1650×2700	2S-2P	1500	800	200	2700×3000	2700×3000	100	80	20	190	150	55	5
	60															
3000 (Single Opening)	30	2000×2770	2050×2970	2S-2P	1800	950	200	3150×3270	3150×3270	150	120	30	300	220	85	5
	60															

Load (kg)	Speed (m/min)	Overhead Height (mm)	Pit Depth (mm)
1600	30	4000	1350
	60	4050	1350
2000	30	4000	1350
	60	4050	1350
3000	30	4000	1350
	60	4050	1350

Load (kg)	Speed (m/min)	Maximum Number of Stops	Maximum Travel (m)	Minimum Floor Height (mm)
1600/2000/3000	30	8	40	2800
	60	16	70	

Note:

- ① The information and dimensions above are based on GB standards.
- ② Configuration is without counterweight safety gear and with decoration weight provision up to 300kg.
- ③ The overhead height above is based on bare ceiling height of 2200mm.
- ④ The pit depth above is based on standard checkered steel plate finish without floor recess.

Hoistway and Machine Room

Hoistway and Machine Room

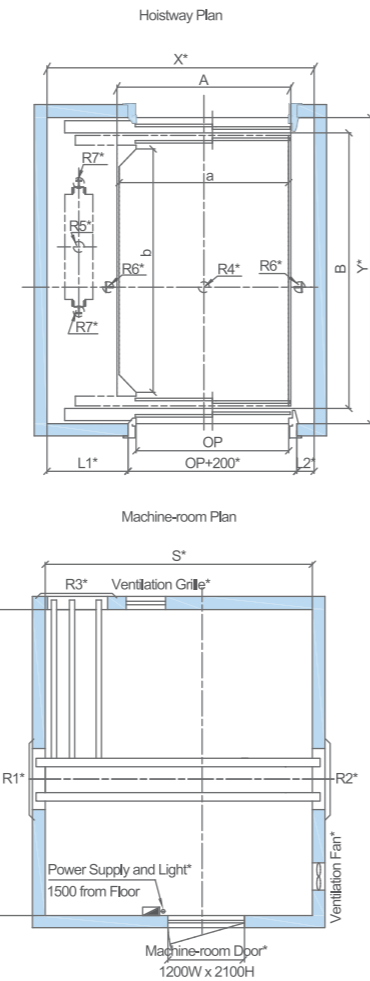
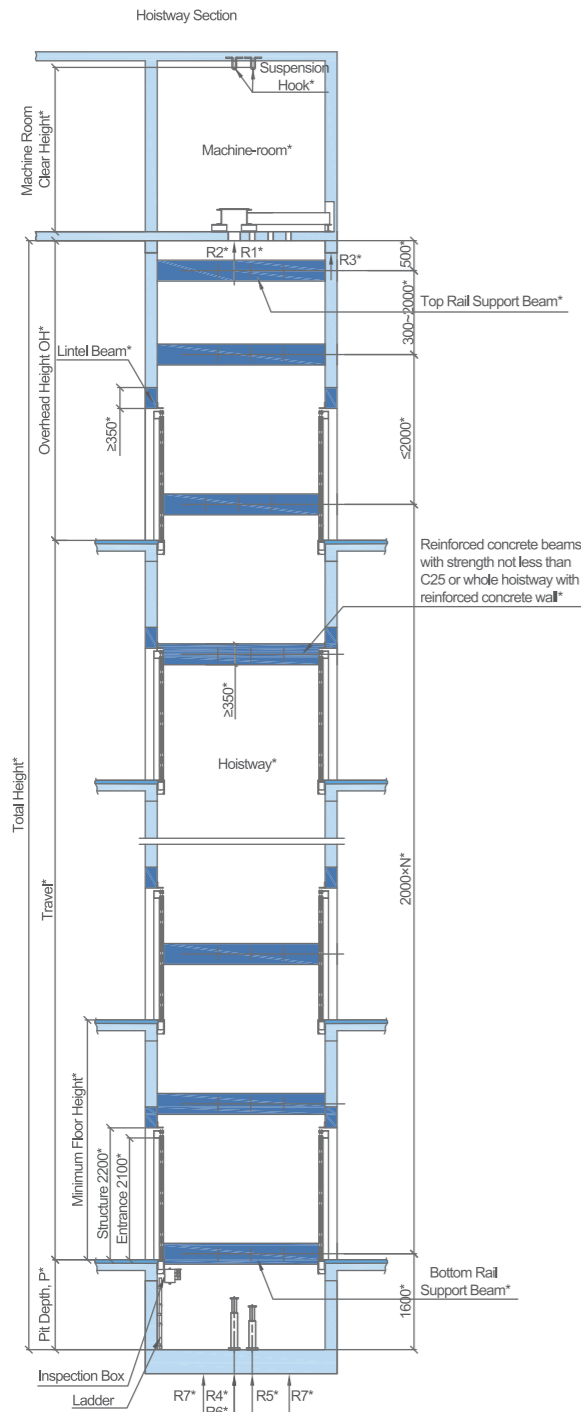

Note:

- ① Items with "*" shall be furnished by building contractors.
- ② Hoistway shall not be located next to bedrooms, classroom, ward, library or any other places where low noise is required.
- ③ The hoistway construction shall be reinforced concrete ring beam with strength C25 or whole hoistway of reinforced concrete wall. If you have other situations, please contact us.
- ④ For hoistway and machine room details, please contact us.
- ⑤ Unit of dimension shall be in mm unless otherwise stated.

Load (kg)	Speed (m/min)	Machine Room Clear Height (mm)	Number of Suspension Hooks (Per lift)	Suspension Hook Capacity (Tons)
1600	30/60	2500	3	3
2000	30/60	2500	3	4
3000	30/60	2500	3	5

Load (kg)	Speed (m/min)	Car Size (mm)		Door Opening (mm)		Front Wall Arrangement (mm)		Hoistway (mm)	Machine Room (mm)	Reaction Loading (KN)						
		Internal (a×b)	External (A×B)	Type	Width (OP)	L1	L2			Machine Room			Pit			
								X×Y	S×T	R1	R2	R3	R4	R5	R6	R7
1600 (Double Opening)	30	1600×2200	1650×2520	2S-2P	1500	800	200	2700×2940	2700×2940	90	70	20	170	140	55	5
	60															
2000 (Double Opening)	30	1600×2600	1650×2920	2S-2P	1500	800	200	2700×3340	2700×3340	100	80	20	190	150	55	5
	60															
3000 (Double Opening)	30	2000×2870	2050×3190	2S-2P	1800	950	200	3150×3610	3150×3610	150	120	30	300	220	85	5
	60															

Load (kg)	Speed (m/min)	Overhead Height (mm)	Pit Depth ⑤ (mm)
1600	30	4000	1350/1720
	60	4050	1350/1720
2000	30	4000	1350/1720
	60	4050	1350/1720
3000	30	4000	1350/1720
	60	4050	1350/1720

Load (kg)	Speed (m/min)	Maximum Number of Stops	Maximum Travel (m)	Minimum Floor Height (mm)
1600/2000/3000	30	8	40	2800
	60	16	70	

Note:

- ① The information and dimensions above are based on GB standards.
- ② Configuration is without counterweight safety gear and with decoration weight provision up to 300kg.
- ③ The overhead height above is based on bare ceiling height of 2200mm.
- ④ The pit depth above is based on standard checkered steel plate finish without floor recess.
- ⑤ When the front/rear entrance open on the lowest floor and there is no openings on the same side at other floors, pit depth shall be 1720mm. Otherwise, pit depth shall be 1350mm.

Hoistway and Machine Room

Hoistway and Machine Room

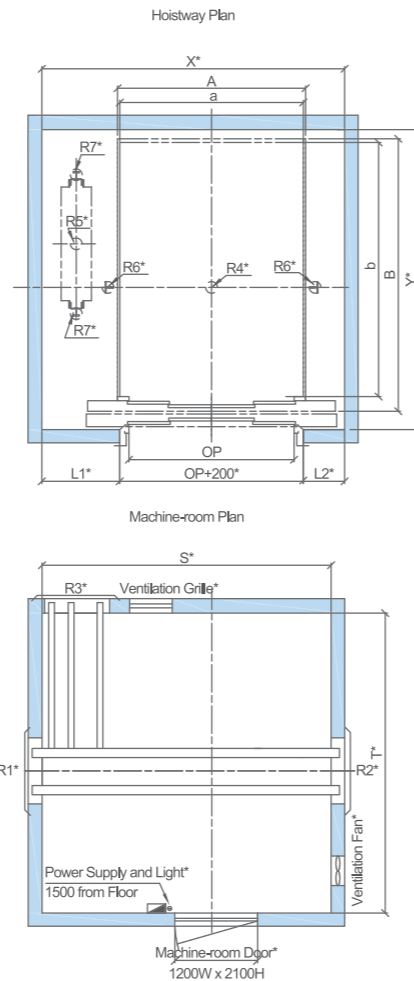
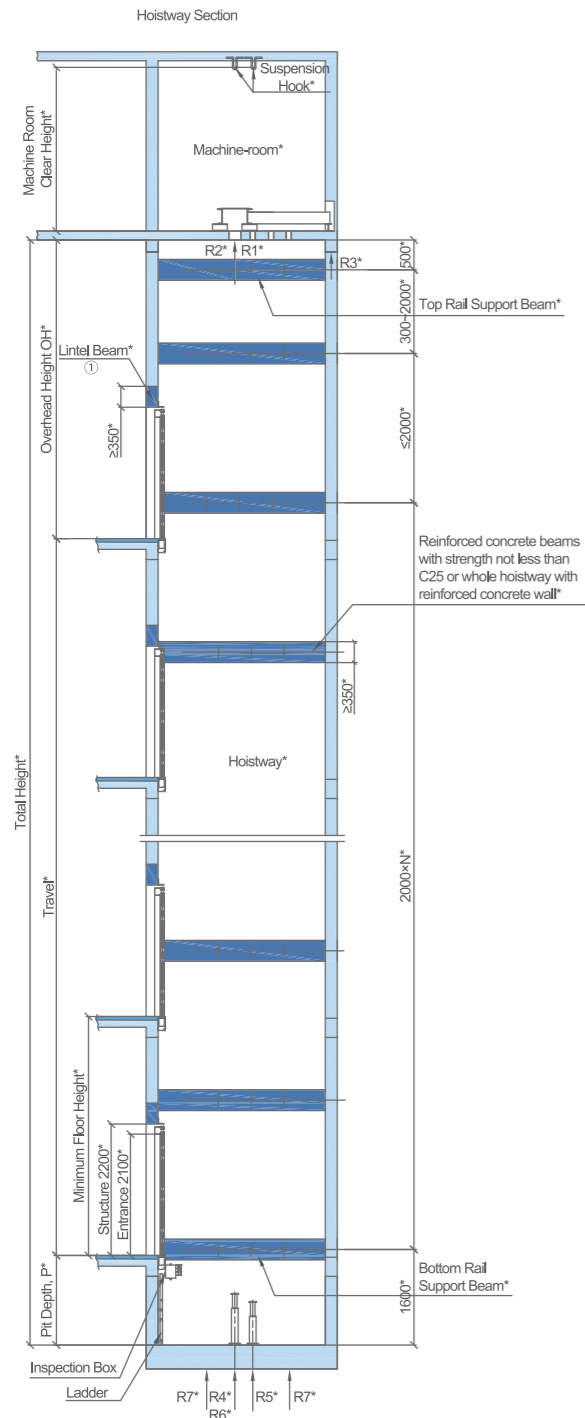

Note:

- ① Items with "*" shall be furnished by building contractors.
- ② Hoistway shall not be located next to bedrooms, classroom, ward, library or any other places where low noise is required.
- ③ The hoistway construction shall be reinforced concrete ring beam with strength C25 or whole hoistway of reinforced concrete wall. If you have other situations, please contact us.
- ④ For hoistway and machine room details, please contact us.
- ⑤ Unit of dimension shall be in mm unless otherwise stated.

Load (kg)	Speed (m/min)	Machine Room Clear Height (mm)	Number of Suspension Hooks (Per lift)	Suspension Hook Capacity (Tons)
1600	30/60	2500	3	3
2000	30/60	2500	3	4
3000	30/60	2500	3	5

Load (kg)	Speed (m/min)	Car Size (mm)		Door Opening (mm)		Front Wall Arrangement (mm)		Hoistway (mm) X×Y	Machine Room (mm) S×T	Reaction Loading (KN)						
		Internal (a×b)	External (A×B)	Type	Width (OP)	L1	L2			Machine Room			Pit			
										R1	R2	R3	R4	R5	R6	R7
1600 (Single Opening)	30	1600×2100	1650×2300	4P-CO	1500	650	450	2800×2600	2800×2600	90	70	20	170	140	55	5
	60															
2000 (Single Opening)	30	1600×2500	1650×2700	4P-CO	1500	650	450	2800×3000	2800×3000	100	80	20	190	150	55	5
	60															
3000 (Single Opening)	30	2000×2770	2050×2970	4P-CO	1800	850	450	3300×3270	3300×3270	150	120	30	300	220	85	5
	60															

Load (kg)	Speed (m/min)	Overhead Height (mm)	Pit Depth (mm)
1600	30	4000	1350
	60	4050	1350
2000	30	4000	1350
	60	4050	1350
3000	30	4000	1350
	60	4050	1350

Load (kg)	Speed (m/min)	Maximum Number of Stops	Maximum Travel (m)	Minimum Floor Height (mm)
1600/2000/3000	30	8	40	2800
	60	16	70	

Note:

- ① The information and dimensions above are based on GB standards.
- ② Configuration is without counterweight safety gear and with decoration weight provision up to 300kg.
- ③ The overhead height above is based on bare ceiling height of 2200mm.
- ④ The pit depth above is based on standard checkered steel plate finish without floor recess.

Entrance Design

Elevation of Entrance with Narrow Jamb (AS-1X)

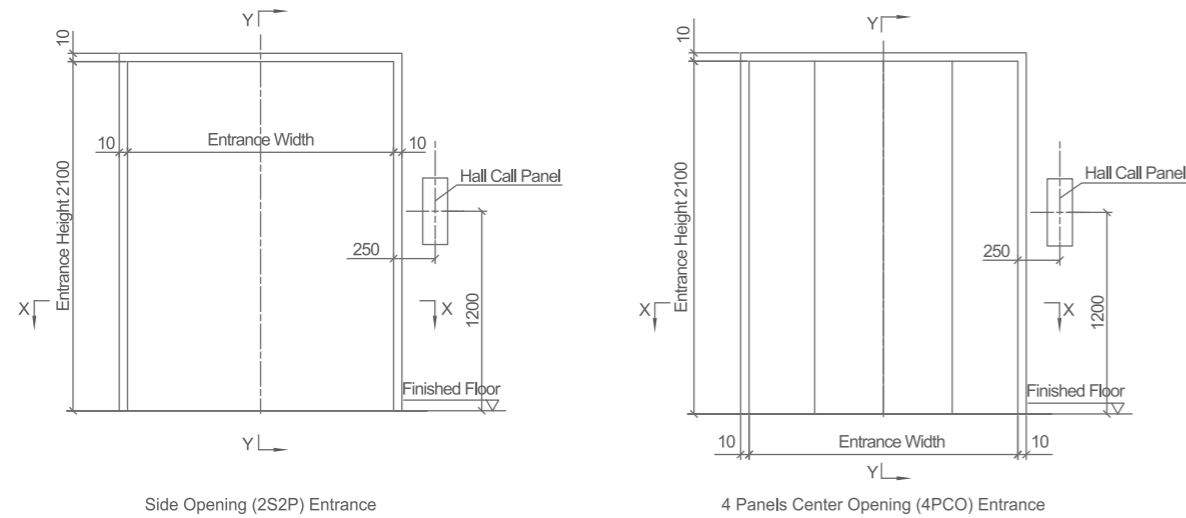

Structure Opening of Entrance with Narrow Jamb (AS-1X)

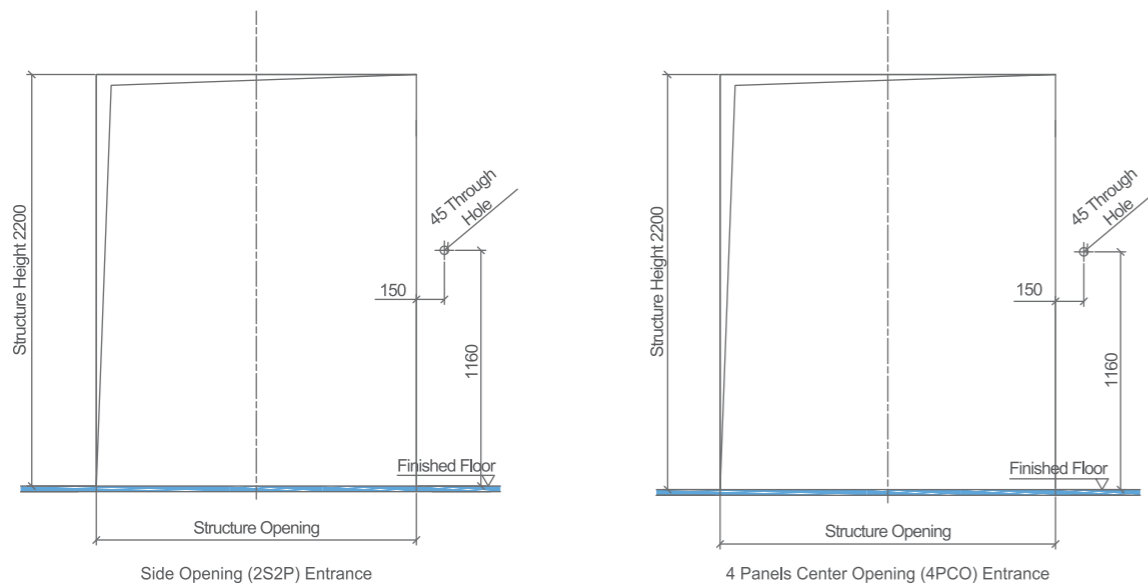



Note:

- ① Structural opening of entrance shall be furnished by building contractor.
- ② Unit of dimension shall be in mm unless otherwise stated.

Entrance Design

The followings shall be furnished by building contractors:

-  Building Structure
-  Wall and Floor Finishes
-  Grouting Work

Side Opening (2S2P) with Narrow Jamb (AS-1X)

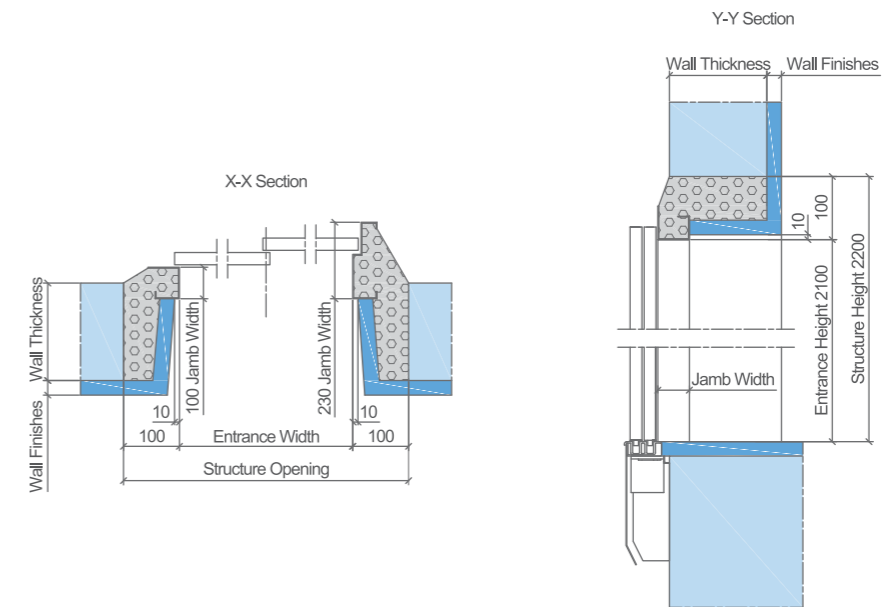

4 Panels Center Opening (4PCO) with Narrow Jamb (AS-1X)

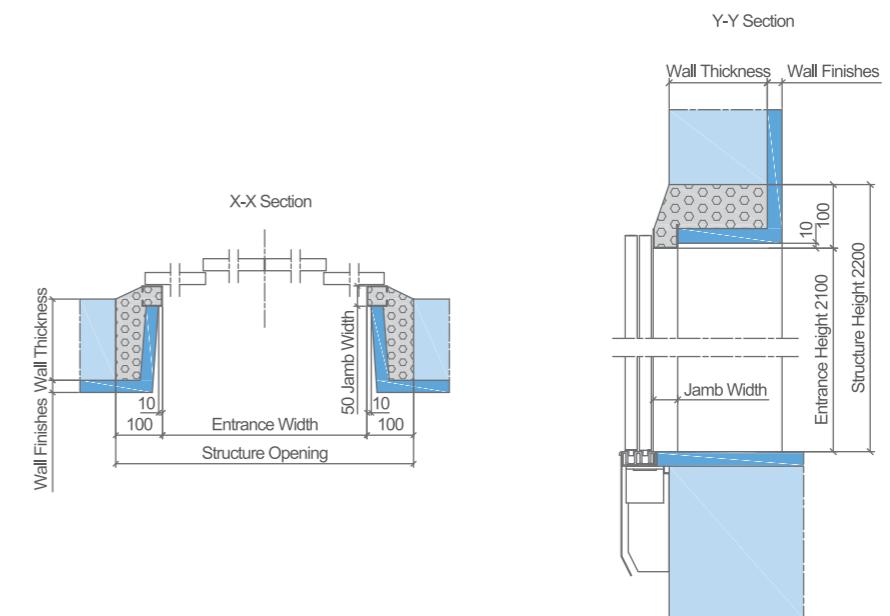

Electrical Information

The followings shall be furnished by building contractors:

~ Electrical Equipment

— Cable

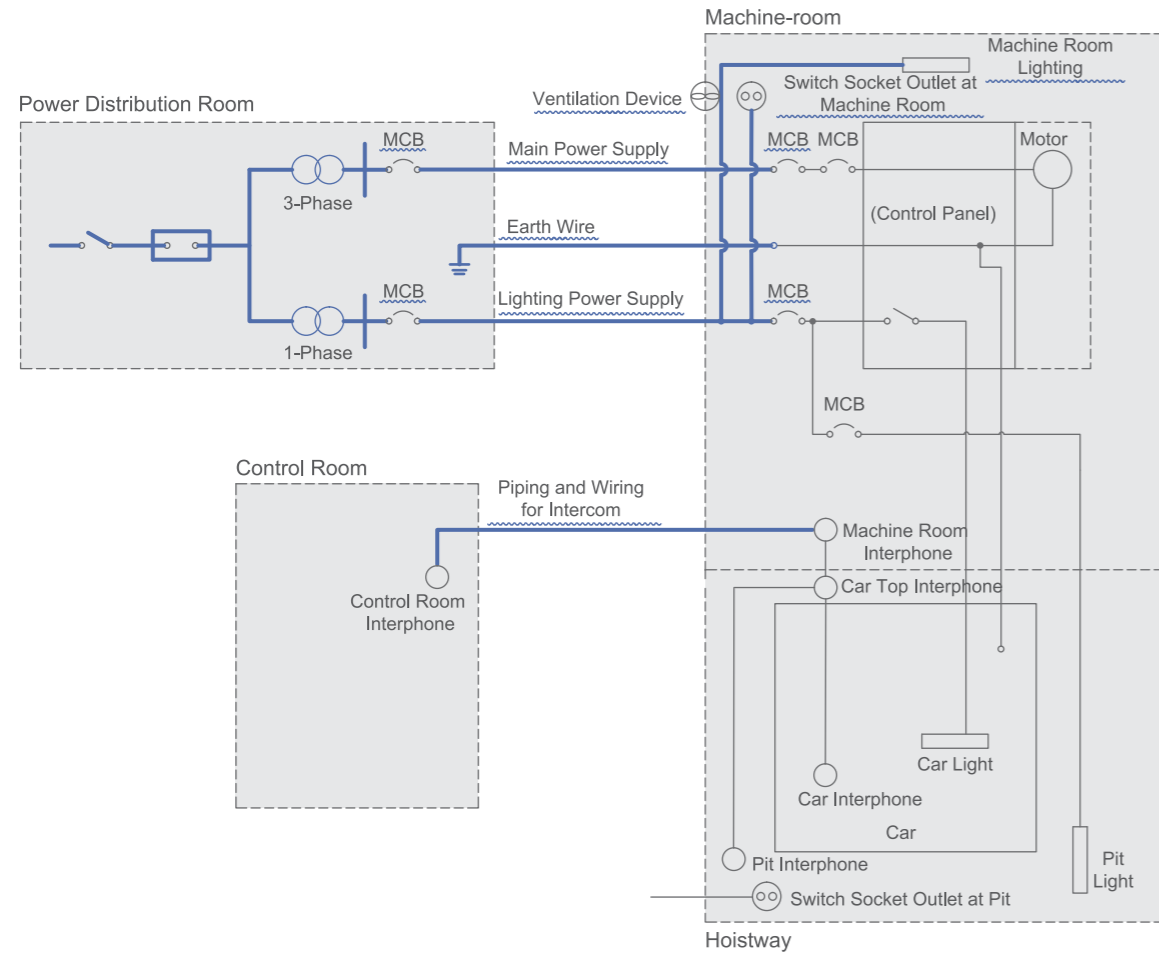

Note:

- ① Main Power Supply: Three-phase, five wires system, AC380V 50Hz
- ② Lighting Power Supply: Single-phase-, three wires system, AC220V 50Hz

Item	Works to be provided by building contractor
Main Power Supply	To provide power supply switch around the entrance of machine room. To install facilities to ensure that power supply voltage fluctuation shall be within $\pm 7\%$.
Lighting Power Supply	To provide lighting power supply for car lighting, fan and indicator.
Ventilation Device	To provide mechanical ventilation to the machine room to ensure that the temperature in the machine room is maintained at below 40°C.
Pit Light, Switch Socket Outlet	To provide single phase AC 220V, 10A switch socket outlet and pit lighting with switch below the entrance floor level for maintenance purposes.

Electrical Data

No.	Load (kg) - Speed (m/min)	Voltage	Circuit Breaker Capacity (A)		Transformer Capacity (kVA)		Main Power Wire Size (mm ²)		Earth Wire Size (mm ²)		Machine Room Ventilation (For One Elevator)		
			1 unit	2 unit	1 unit	2 unit	1 unit	2 unit	1 unit	2 unit	Heat Calorific (J.10 ⁶ /h)	Amount of Air to be Ventilated (m ³ /h)	Ventilation Fan Size Dia (Φmm)
1	1600-30	3φ380V 1φ220V 50Hz	20	30	8	13	8	10	8	10	5.03	581.33	250
	1600-60		40	50	13	20	16	25	16	16	10.06	1152.76	300
2	2000-30		30	40	8	16	8	16	8	16	6.29	724.19	250
	2000-60		50	60	16	25	16	30	16	16	12.57	1438.47	300
3	3000-30		40	50	13	20	10	25	10	16	9.43	1081.33	300
	3000-60		60	100	25	40	25	35	16	16	18.85	2152.76	350

Note:

- ① The above main power wire size is based on length less than 150m.
- ② For wire length more than 150m, please calculate the wire size using the formula below:
Wire Size (mm²) = [Actual wire length / 150] × [Wire size in above tabulation]

