

# Machine Room-less Elevator

Model LCA



Contact Address:

The information in this catalogue is subject to change without notice. The information and diagram in this catalogue reflect the technical feature and configuration of the elevator model at press time (refer to the version number). In line with the principle of continuous development of products, our company reserves the right to change the selection of product technical parameters and colour at any time. The existing image technology cannot accurately reproduce the elevator component structure and decoration colour. Therefore, this catalogue only provides general information, not as a contract document. The specific configuration parameters are subject to the formal agreement. If you need detailed information, please contact us.



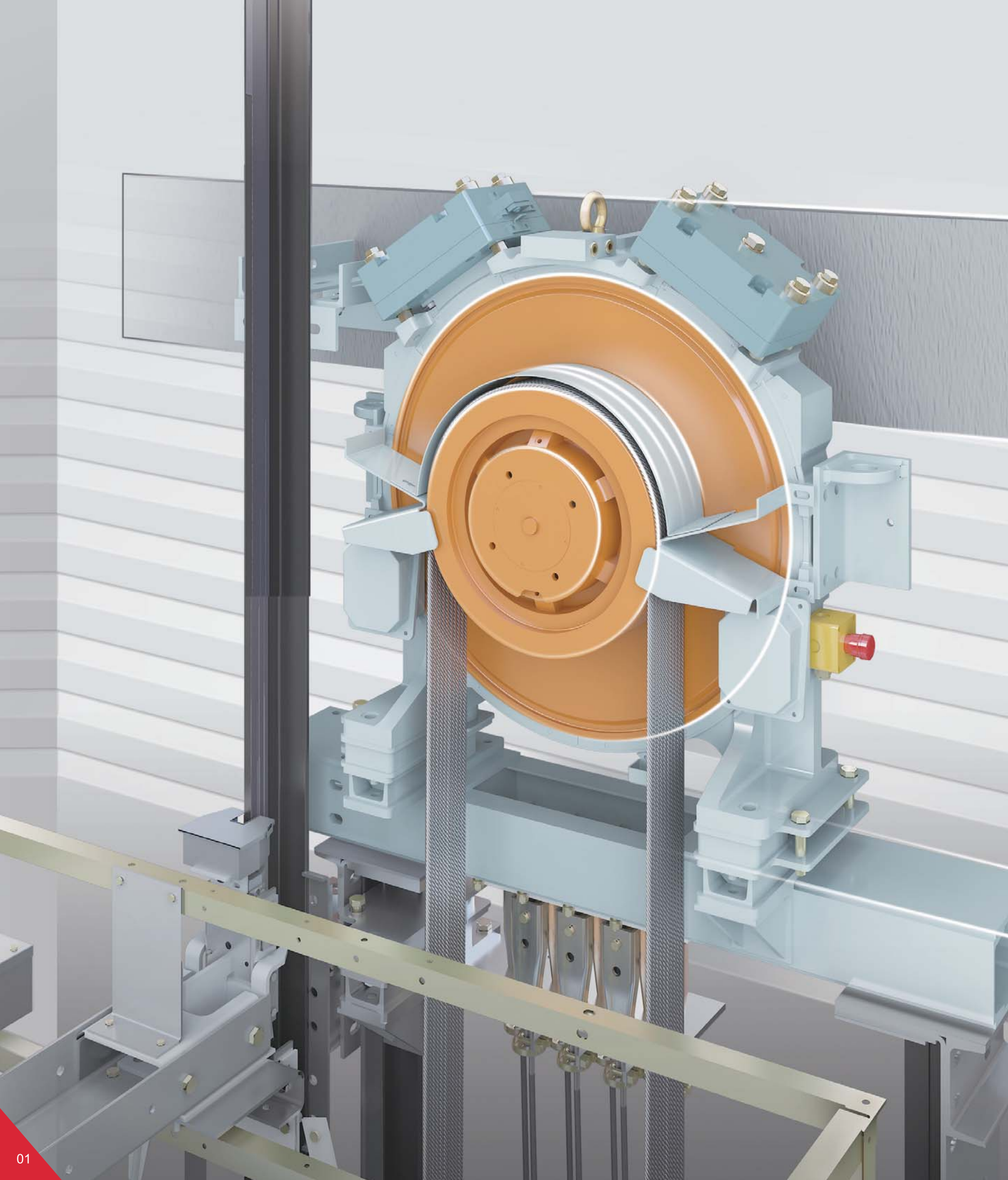

## Self-Supporting Structure and Anti-Quake Design

### 01 Self-Supporting Traction Machine

The traction machine is supported by three guide rails directly at the top of the hoistway. It is not necessary for the building contractor to reserve support beams or installation openings in the hoistway walls.

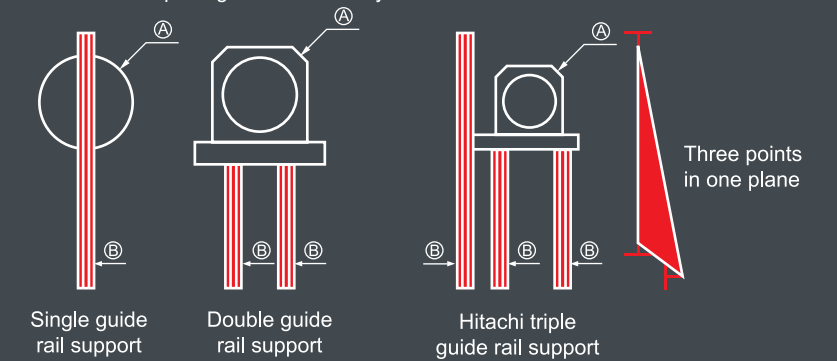

Note: Part ① is traction machine.  
Part ② is guide rail.

### 02 Anti-Quake Design

The traction machine is equipped with an anti-toppling device which can prevent the traction machine from falling in case of an earthquake. In addition, the anti-dropout design is also adopted for the counterweight and car frame. These designs reduce the impact of an earthquake and protect the passengers.

# Traction Machine Safety and Comfort

## 01 High Braking Torque

- ✓ The tractive capacity is designed to Hitachi standards which exceeds the industry standards to ensure that the elevator runs more reliably;
- ✓ The braking torque is designed to Hitachi standards which is significantly higher than industry standards to ensure maximum safety and reliability;
- ✓ The brake is subject to rigorous testing conducted by Hitachi to ensure safety, reliability and high performance for long-term operation.

## 02 Motor Temperature Rise Control

The temperature of the motor rises at a slower rate as compared to other permanent magnet synchronous motors available in the market, through Hitachi temperature control technology. Lifespan of the motor can be extended by reducing the common risks of malfunction caused by overheating motors.

## 03 Riding Comfort

The effects of the vibration from the motor and guide rail is stabilized through the highly efficient dampers for the traction machine to provide a comfortable riding experience for the passengers.

## 04 Class-F Insulation of Motor

The motor is designed with industry leading heat resistant technology which can withstand extremely high temperature of up to 155°C. It is classified as Class-F, the highest rating of insulation in the industry.

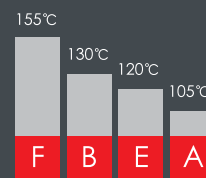

## 05 Minimal Motor Torque Pulsation

The low torque ripple of the motor enhances ride quality.

Note: The "industry standards" mentioned above refers to GB standards.

# Representative Patent Design

## 01 Separable Traction Sheave Design

The unique separable traction rope sheave design reduces the maintenance labour time and maintenance cost of motor.

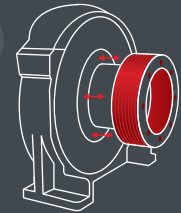

## 02 Higher Rotation Accuracy

The traction machine of LCA elevator adopts taper roller bearings characterized by increased bearing capacity, longer lifespan and higher rotation accuracy. With the taper roller bearings, the rope-groove vibration is restricted to 1/3 of the value specified by the industry standards, enhancing the riding comfort of the elevator.

## 03 Magnet Steels Dropout-Proofing Patent of the Motor

As compared with conventional practice to fix magnet steel with adhesion agent, the patented holding-down mechanism designed by Hitachi secures the magnet steels onto the rotor, avoiding dropout of magnet steel caused by failure of the adhesion agent.



Note: The "industry standards" mentioned above refers to GB standards.



# Intelligent Door System

## 01 Intelligent Multi-Beam Protection

### Auto energy-saving

It can judge whether the elevator is unoccupied. When the elevator is unoccupied, the multi-beam will be powered off so as to reduce the energy consumption and extend the lifespan of multi-beam.

### Auto detection

It can judge the specific location of multi-beam malfunction and provide reference for quick rectification.

### Automatic shielding

If a single point of the multi-beam is obstructed or damaged, the system will shield the bad point, record the fault and then close the door normally on the premise of safety.

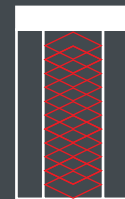

## 02 High-Performance Processor

High-performance processor(32-bit DSP) serves as kernel control in LCA elevator. The four-layer control board is provided with high interference eliminating features and the highly-integrated module technology is adopted in the control system. These features completely improve the response speed and reliability of the control system.



Note: 32-bit DSP processor

## 03 The Latest IPM Module Based on SVPWM

Double closed-loop vector(current and speed) control method which is based on SVPWM tuning control technology and vector control algorithm, is adopted. The latest IPM module serves as the inverter power module. As a result, door opening/closing operations are smooth and with low noise.



## 04 Intelligent Features

### Door-width self-learning

The system can learn the specification and adjust the door opening and closing curve according to the door width data collected automatically. The data is saved in the EEPROM and the data is still saved after power off.

### Door-weight self-adaption

The system can adjust different door-weight at each floor within standard.

### Malfunction self-detection and self-protection

The system can judge when there is a breakdown and stops the elevator as needed.

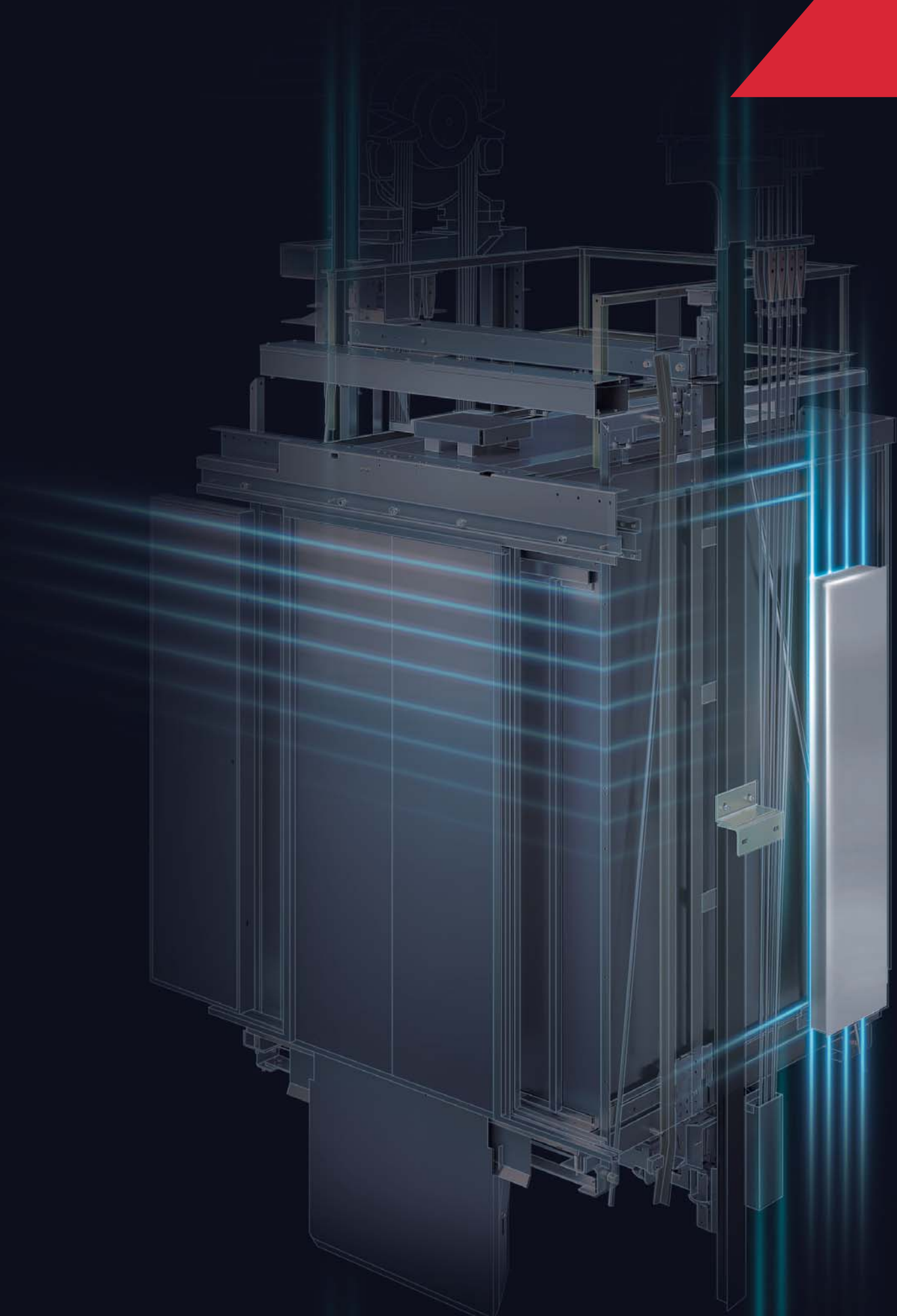

# Innovative and Eco-Friendly Technology

## 01 Non-welded Car Frame and Double-layer Car Platform

- ✓ Non-welded car frame  
Non-welded car frame requires no manual welding on site and helps reduce the environmental pollution, improve the strength of car frame and achieve a higher safety and reliability rating.
- ✓ Double-layer car platform  
Double-layer car platform is characterized by vibration-proof materials are set between the car platform and the car platform frame. The elevator with double-layer car platform will travel much more smoothly and comfortably than other elevator with single-layer car platform through isolating the vibration of the car platform frame from the car platform.



## 02 Laser Cutting Technology

Laser cutting technology is applied in Hitachi elevator. In comparison with other standard methods, laser cutting technology significantly enhances the product cutting quality and accuracy. Laser cutting also benefits with lower carbon footprints.

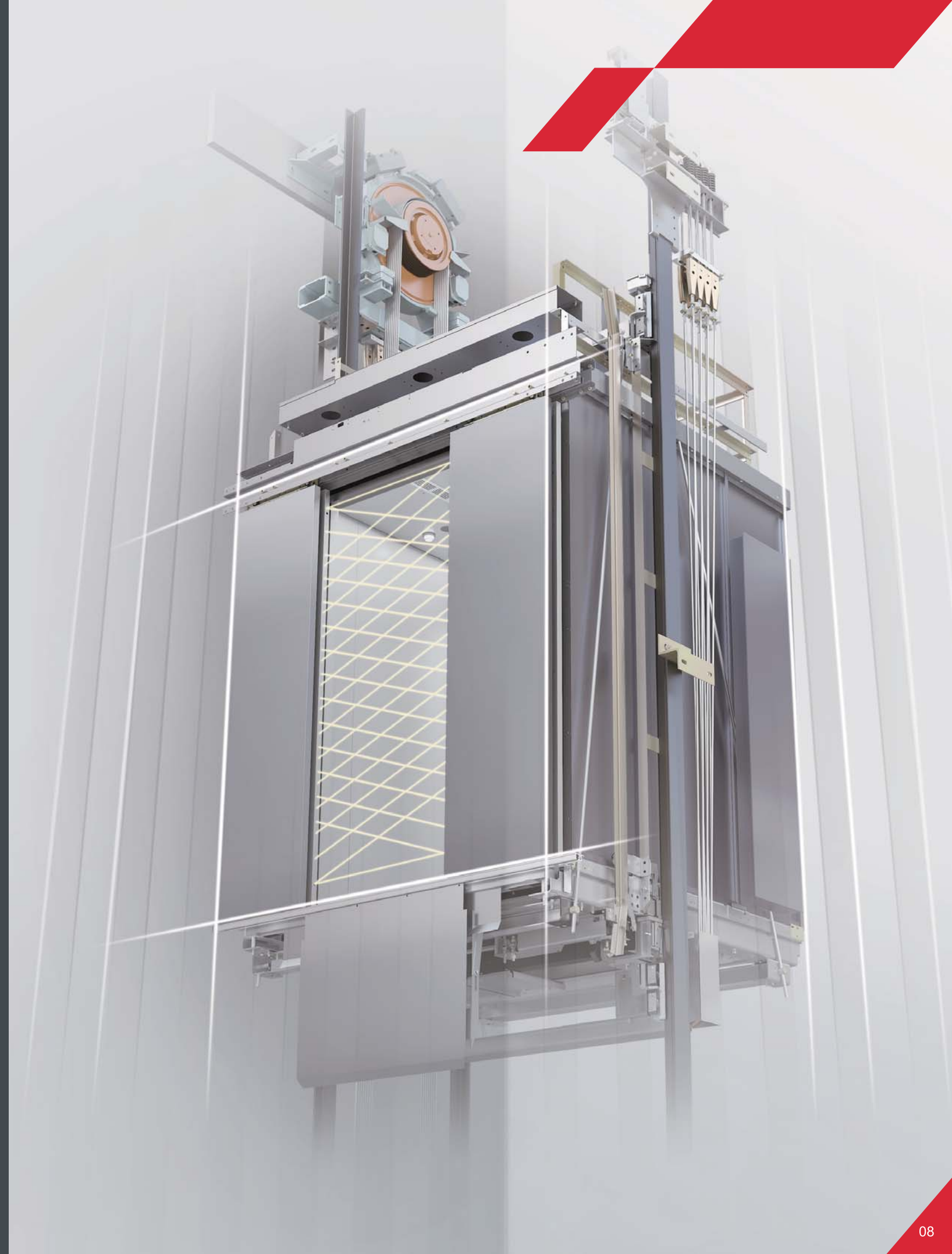
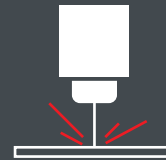

# High Efficiency and Energy Saving

## 01 Stepless Speed Control

Hitachi elevator has been adopting step-less speed control for many years. With Hitachi's highly efficient control system, the precise optimum travelling speed curve can be directly calculated by the output according to the distance from the car location to the destination.

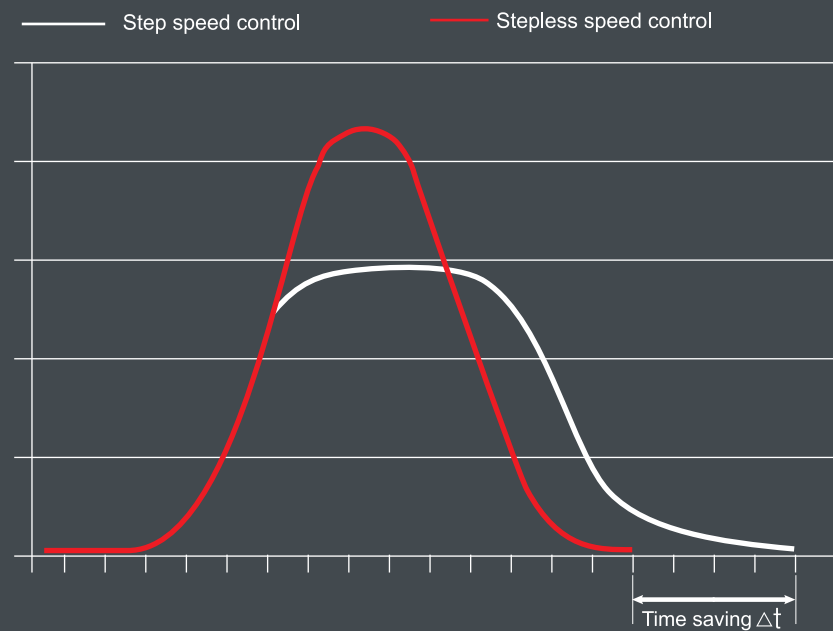

## 02 Energy Efficiency

Hitachi LCA machine room-less elevator achieved the highest rating of Class A for VDI4707 energy efficiency certification.

Energy Efficiency Class A

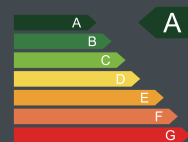

Model: LCA-1600-CO150  
 Test location: China  
 Nominal load: 1600kg  
 Nominal speed: 2.5m/s  
 Operating days per year: 365  
 Nominal energy demand per year: 4326 kWh  
 Note: The measured class differs depending on the usage conditions.

# Industrial-Leading Technology

## 01 Reliable High-frequency Impulse Voltage Transformer Communication

Hitachi elevator adopts high-frequency impulse voltage transformer serial communication technology exclusively. It's mainly applied in some special industries such as telecommunication and military communication due to its stronger resistance to interference and higher velocity.

Content	Hitachi standard
Communication mode	High-frequency impulse voltage transformer
Reliability	High
Resistance to interference	Strong
Max.Speed	125kb(increase by 25%)

## 02 Advanced Control System

Multi-processor, Smaller size, Higher integration level  
 Higher running speed and outstanding processing capacity improve the efficiency and energy conservation effect.



Note:32 bit processor

## 03 High Precision Digitized Starting Torque Compensation

The high precision load transducer can accurately calculate the load of the car so that the traction machine is able to compensate the startup torque precisely and achieve a more comfortable start .







## Humanised Design

### 01 Eco-Friendly LED Lighting Design

The use of LED helps to create a cozy atmosphere for the passengers, with its DC powered, flicker-free, energy efficiency features.

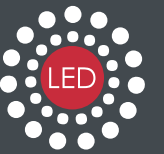

### 02 Horizontal Car Operating Panel [Option]

Horizontal car operating panel is available to provide the passengers with an easy elevator-taking environment.



## Car Design (Normal Car)

Ceiling height: 2300mm

Car ceiling: RF-018

Stainless steel hairline

Center: Painted steel\_HP65 (Matte black) + LED downlight

Car front return panel: Stainless steel hairline

Car transom: Stainless steel hairline

Side walls: Stainless steel hairline

Rear walls: Stainless steel hairline+Stainless steel mirror bar

Car door: Stainless steel hairline

Car operating panel: GOPR-820

Car position indicator: Monochrome LCD

Floor: A-26



## Car Design (Deep Car)

Ceiling height: 2300mm

Car ceiling: RF-018

Stainless steel hairline

Center: Painted steel\_HP65 (Matte black) + LED downlight

Car front return panel: Stainless steel hairline

Car transom: Stainless steel hairline

Side walls: Stainless steel hairline

Rear walls: Stainless steel hairline+Stainless steel mirror bar

Car door: Stainless steel hairline

Car operating panel: GOP-199

Car position indicator: Monochrome LCD

Floor: A-26





## Car Operating Panel

(With faceplate: Stainless steel hairline)















<b>Standard</b>		<b>Option</b>					
							
GOPR-820 Indicator: Monochrome LCD Button: WL-MWB (Hinge type)	GOP-199 Indicator: Monochrome LCD Button: WL-MWB (At side wall)	OPM-320 Indicator: Monochrome LCD Button: WL-MW	GOP-673 Indicator: Monochrome LCD Button: WL-MW	GOP-680 Indicator: Monochrome LCD Button: FL-PW	GOP-677 Indicator: Colour LCD Button: FL-PW (Hinge type)	GOP-678 Indicator: Colour LCD Button: WL-MWB (Hinge type)	GOP-198 Indicator: Monochrome LCD Button: WL-MW (At side wall)

## Option Horizontal Car Operating Panel

(With faceplate: Stainless steel hairline)

	
GOP-610 Button: FL-PW	GOPC-520 Button: FL-PW











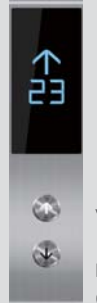

## Button

<b>Standard</b>	<b>Option</b>						
							
WL-MWB	WL-MW	WL-MO	WL-MB	XL-MW	XL-MO	XL-MB	FL-PW
							
	GL-MW	GL-MOA	GL-MB	XL-MWA	XL-MOA	XL-MBA	HL-PWA

Note: Braille buttons are of maximum 2 digits and available as option.

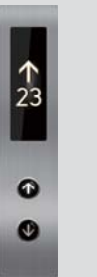
## Hall Operating Panel

(With faceplate: Stainless steel hairline)

<b>Standard</b>			<b>Option</b>					
								
VIB-820 Indicator: Monochrome LCD, Button: WL-MWB (Surface-mount type)	VIB-820W Indicator: Monochrome LCD, Button: WL-MWB (Surface-mount type)	*For Top Floor Only VIB-715 With inspection function Indicator: Monochrome LCD, Button: WL-MWB (Embedded type)	VIB-320 Indicator: Monochrome LCD, Button: WL-MW (Surface-mount type)	VIB-320W Indicator: Monochrome LCD, Button: WL-MW (Surface-mount type)	VIB-673 Indicator: Monochrome LCD, Button: WL-MW (Surface-mount type)	VIB-673W Indicator: Monochrome LCD, Button: WL-MW (Surface-mount type)	VIB-680 Indicator: Monochrome LCD, Button: FL-PW (Surface-mount type)	VIB-680W Indicator: Monochrome LCD, Button: FL-PW (Surface-mount type)
								
VIB-187A Indicator: Colour LCD, Button: FL-PW (Embedded type)	VIB-187WA Indicator: Colour LCD, Button: FL-PW (Embedded type)	HB-658 Button: FL-PW (Surface-mount type)	HB-673 Button: WL-MW (Surface-mount type)	HBC-820 Button: WL-MWB (Surface-mount type)				



## Option Hall Lantern

(With faceplate: Stainless steel hairline)

		
GHL-673 Surface mounted type, With chime	GHL-820 Surface mounted type, With chime	GHL-668 Surface mounted type, Without chime

## Option Hall Indicator

(Dot-matrix display)

	
GHI-575 Without faceplate: incorporate into transom	GHI-675 With faceplate: stainless steel hairline

## Ceiling (Without Car Top Emergency Exit)



**RF-018 (Standard)** ①  
Stainless Steel Hairline +  
Painted Steel\_HP65 (Matte Black)



**RF-068** ①  
Painted Steel\_WP71 (White)



**RF-080** ①  
Painted Steel\_HP57 (Matte Light Brown)



**CE-011** ①  
Painted Steel\_YM47 (Matte Champagne)



**CE-027**  
Acrylic Panel + Aluminum Frame



**DX-301G**  
Acrylic Panel + Aluminum Frame



**DP-047**  
Stainless Steel Hairline +  
Painted Steel\_HP57 (Matte Light Brown)



**RF-013** ①  
Painted Steel\_BN18 (Grey)



**RF-081** ①  
Painted Steel\_HP57 (Matte Light Brown)



**RF-082** ①  
Painted Steel\_WN01 (Ivory White)



**CE-015** ①  
Painted Steel\_HM03 (Matte Silver)



**DP-016**  
Painted Steel\_YM47 (Matte Champagne)



**DP-017**  
Painted Steel\_YM47 (Matte Champagne)



**RF-056** ①  
Painted Steel\_BN18 (Grey)  
(Select when false ceiling is by Client)

Note:

- ① Ceiling is with deep car option.
- ② The ceilings illustrated above are based on 1600×1500mm car size.
- ③ The ceiling profile may vary with different car size.
- ④ Details, please contact us.

## Ceiling (With Car Top Emergency Exit)



**RF-013A**  
Painted Steel\_WN01 (Ivory White)



**RF-081A**  
Painted Steel\_HP57 (Matte Light Brown)



**RF-082A**  
Painted Steel\_WN01 (Ivory White)



**CE-015A**  
Painted Steel\_WN01 (Ivory White)



**DP-016A**  
Painted Steel\_YM47 (Matte Champagne)



**DP-017A**  
Painted Steel\_YM47 (Matte Champagne)



**RF-056A** ①  
Painted Steel\_WN01 (Ivory White)  
(Select when false ceiling is by Client)

Note:

- ① Ceiling is with deep car option.
- ② The ceilings illustrated above are based on 1600×1500mm car size.
- ③ The ceiling profile may vary with different car size.
- ④ Details, please contact us.



# Entrance

**Standard**



Jamb frame: AS-1X narrow type  
Stainless steel hairline  
Door panel: Stainless steel hairline  
Door sill: Extruded hard aluminum

**Option**



Jamb frame: SS-1X wide type  
Stainless steel hairline  
Door panel: Stainless steel hairline  
Door sill: Extruded hard aluminum



Jamb frame: TS-1X wide type  
Stainless steel hairline  
Door panel: Stainless steel hairline  
Door sill: Extruded hard aluminum



Jamb frame: SL-2X wide type with transom  
Stainless steel hairline  
Door panel: Stainless steel hairline  
Door sill: Extruded hard aluminum



Jamb frame: TL-2X wide type with transom  
Stainless steel hairline  
Door panel: Stainless steel hairline  
Door sill: Extruded hard aluminum

## Etching Pattern

**Option**



MD-315



MD-351



PT-014

**Option**



Rose Gold



Titanium Gold



Champagne Gold

## Colour Stainless Steel Hairline

## Option Decorated Steel



GSDV5



GSD92508



GSDV7

## Standard Car Floor (Vinyl Tile)



A-26

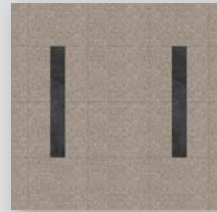

FL-P008  
\*The image above represents the whole floor area in the elevator car.

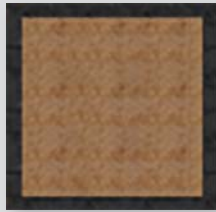

FL-P009  
\*The image above represents the whole floor area in the elevator car.



S-033



S-048



S-693

## Option Handrail



AA-Y138  
Stainless steel hairline or mirror



AA-BS  
Stainless steel hairline



HR-M037  
Stainless steel hairline



HR-M050  
Stainless steel hairline or mirror

## Car Decoration

Item	Specification	● Standard	● Option
Ceiling Type	Without car top emergency exit: RF-018		●
	Without car top emergency exit: RF-068 / RF-080 / CE-011 / CE-027 / DX-301G / DP-047 / RF-013 / RF-081 / RF-082 / CE-015 / DP-016 / DP-017 / RF-056		○
	With car top emergency exit: RF-013A / RF-081A / RF-082A / CE-015A / DP-016A / DP-017A / RF-056A		○
Car Door/Transom /3 Side Walls /Front Return Wall	Stainless steel hairline		●
	Stainless steel mirror		○
	Stainless steel hairline etching / Stainless steel mirror etching		○
	Colour stainless steel hairline		○
Kickplate	Rust proof painted steel (RPP) / Decorated steel		○
	Stainless steel hairline		●
Car Sill	Extruded hard aluminum		●
	Stainless steel hairline		○
Car Floor	Vinyl tile (FL-P009 / FL-P008 / S-048 / S-033 / S-693 / A-26)		●
	Floor recess (20mm / 25mm / 30mm), Finishes by Others		○
Handrail	AA-138		○
	AA-BS		○
	HR-M037		○
	HR-M050		○
Car Operating Panel (At Front Return Wall)	GOPR-820		●
	OPM-320 / GOP-673 / GOP-680 / GOP-677 / GOP-678		○
Car Operating Panel (At Side Wall)	GOP-199		●
	GOP-198 / GOP-610 / GOPC-520		○

## Entrance

Item	Specification	● Standard	● Option
Jamb Type	AS-1X, Jamb width=50mm		●
	SS-1X, Jamb width≤300mm		○
	SL-2X, Jamb width≤300mm		○
	TS-1X, Jamb width≤300mm		○
	TL-2X, Jamb width≤300mm		○
Jamb Finish	Stainless steel hairline		●
	Stainless steel mirror		○
	Rust proof painted steel (RPP)		○
Landing Door	Stainless steel hairline		●
	Stainless steel mirror		○
	Stainless steel hairline etching / Stainless steel mirror etching		○
	Colour stainless steel hairline		○
Landing Sill	Rust proof painted steel (RPP) / Decorated steel		○
	Extruded hard aluminum		●
Hall Operating Panel	Stainless steel hairline		○
	Surface-mount type: VIB-820 / VIB-820W		●
	Embedded type: VIB-187A / VIB-187WA		○
Hall Operating Panel with Inspection Function	Surface-mount type: VIB-320 / VIB-320W / VIB-673 / VIB-673W / HB-673 / VIB-680 / VIB-680W / HB-658 / HBC-820		○
	VIB-715		●
Hall Lantern	GHL-673/GHL-668 / GHL-820		○

## Buttons

Item	Specification	● Standard	● Option
Button	WL-MWB		●
	WL-MO / WL-MW / WL-MB / GL-MOA / GL-MW / GL-MB / FL-PW / XL-MO / XL-MW / XL-MB / XL-MOA / XL-MWA / XL-MBA / HL-PWA		○

## Note

