

MACHINE ROOM-LESS ELEVATOR

Model OUG Series ON1



Caring for you, and making you feel comfortable.

HUMAN FRIENDLY

What we are aiming is to fill a building with safe and comfortable products and services, and to make a town even more pleasant for all the people who live, work and visit there. Always caring for you. Always getting close to you. HUMAN FRIENDLY is the R&D concept conveying our thoughts.

 Hitachi Building Systems Co., Ltd.

Contact Address:

The information in this catalogue is subject to change without notice.

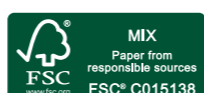

Creating a New History

Hitachi Group is active in a wide range of business sectors. From the technology and experience built up over many years, come the synergies that feed new innovation.

Hitachi has been developing and manufacturing elevators and escalators since 1920s.

As social demands on elevators change over time, Hitachi's machine room-less elevator model OUG series ON1, developed in Japan, meets the needs of customers in terms of efficiency, safety, comfort, and space savings. Hitachi is creating a new history for elevators, and for your building.



History of Hitachi elevators

•**1932**•First elevator is delivered: freight elevator for Tokyo Electric Co. •**1968**•300-m/min. elevator is delivered to Japan's first skyscraper: Kasumigaseki Building. •**1991**•Power-saving inverter-controlled Ultrahigh-Speed elevator commences operations: Tokyo Metropolitan Government Building No.1. •**2003**•300-m/min. double-deck elevator is delivered: Roppongi Hills Mori Tower, Tokyo. •**2007**•480-m/min., 2,850-kg high-rise shuttle elevator is delivered: Tokyo Midtown, Midtown Tower. •**2008**•World's largest Ultrahigh-Speed double-deck elevator is delivered: Shanghai World Financial Center. •**2011**•600-m/min. Ultrahigh-Speed elevator for the Middle East: Al Hamra Mixed-Use Complex, Kuwait. •**2012**•High-Speed, large-capacity elevator providing access to Japan's highest (450 m) observation platform: TOKYO SKYTREE. •**2017**•The tallest building in Singapore, famous as the winner of the World Architecture News Mixed-Use Award: Tanjong Pagar Centre, Singapore. •**2019**•Delivery of the Ultrahigh-Speed elevators, with a speed of 1,260 m/min. (21 m/sec.): Guangzhou CTF Finance Centre (530 m), China.

Four classifications of value we provide for your building

Energy efficiency

Page 5, 6

Reduced energy consumption with standard specifications
Power consumption can be reduced to approximately 1/6.

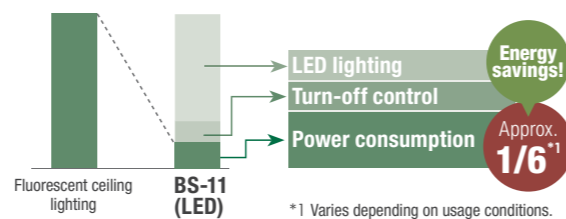

LED lighting

Use of LED lighting reduces the energy consumption by approximately 1/4 and its service life is three times longer compared with fluorescent lighting.

Automatic turn-off of car lighting and fan

Standard

When the elevator is idle, the lighting and ventilation fan in the elevator are automatically turned off to conserve energy. Energy consumption is reduced by adopting LED lighting for the ceiling and by shortening the time until the lighting and fan turn off.

Regenerative system

Option

The traction mechanism acts as a power generator and transmits power back to the building electrical network that reduces energy consumption by approximately 30%.



*2 Effectiveness during normal operation. Differs depending on usage conditions.

Comfort

Page 7, 8

Improved riding comfort

Standard

Motor control and vibration-absorbing type guide shoes provide a quiet and smooth ride.

Group control systems

Option

Group control systems provide passengers with appropriate guidance and help reduce the probability of long waits.

Ion generator

Option

Ion generator works to improve air quality.

Elevator interior deodorizing test*3

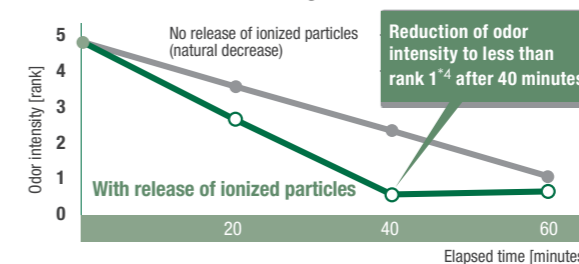

*3 Results after 40 minutes in test performed in (13-passenger) elevator measuring approx. 5.5 m³. Results may differ from those in actual usage space.

*4 Odor strength rank 1 is defined as "extremely weak odor that is hardly noticeable."



* Artist's conception.

Notes
- Testing organization: Hitachi Power Solutions Co., Ltd. Testing method: Verification using six-rank odor intensity indication method in passenger elevator with 13-person capacity. Deodorizing method: Release of ionized particles. Subject: Methyl mercaptan was released and the change in its concentration was measured.

Safety & Emergency

Page 9, 10

Door signal with multi-beam door sensor

Option

Door signal that tells when the door is going to close for enhanced safety.

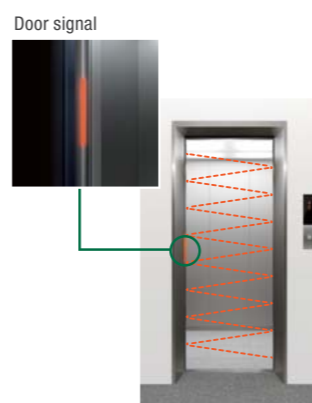

Micro-leveling

Standard

Automatically corrects the elevator landing level when there is a level difference between car and floor.

Automatic rescue device for power failure

Option

When a power failure is detected, the drive power supply switches over to battery power, and the elevator automatically moves to the nearest floor and releases the passengers.

Design

Page 11, 12

LCD indicators

Option

In-car indicator and hall indicator with color LCD are available. They provide a quick overview of the operating status.



Car and hall designs

Select the most suitable design from the options available, including ceiling and 3 side walls designs created by Hitachi's designers to match a variety of building types.



Energy efficiency

LED lighting

By adopting LED lighting for all ceiling designs, energy consumption is reduced and service life is prolonged compared with fluorescent lighting.

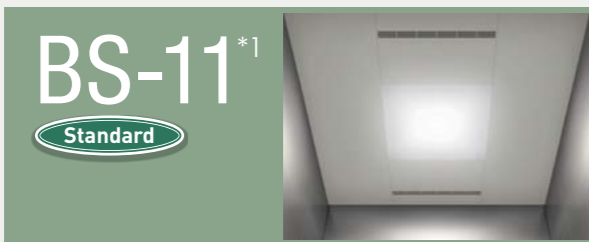

Power consumption approx. 1/3 that of fluorescent lighting
Employs LED lighting with **approx. 3x² longer service life.**

	Fluorescent ceiling lighting	BS-11 (LED)
Power consumption	69 W	23 W ³
Service life	Approx. 12,000 hours	Approx. 40,000 hours ⁴

Power consumption approx. 1/6 that of fluorescent lighting
Employs LED lighting with **approx. 3x² longer service life.**

	Fluorescent ceiling lighting	SL-11 (LED)
Power consumption	207 W	33 W ³
Service life	Approx. 12,000 hours	Approx. 40,000 hours ⁴

By changing the time until the lighting turns off during standby from three minutes to one minute...

Power consumption can be reduced to approx. 1/6

	Fluorescent ceiling lighting	BS-11 (LED)
Annual illumination duration	Approx. 3,000 hours	Approx. 1,500 hours ⁵
Annual power consumption	Approx. 207 kWh/year	Approx. 35 kWh/year

By changing the time until the lighting turns off during standby from three minutes to one minute...

Power consumption can be reduced to approx. 1/12

	Fluorescent ceiling lighting	SL-11 (LED)
Annual illumination duration	Approx. 3,000 hours	Approx. 1,500 hours ⁵
Annual power consumption	Approx. 621 kWh/year	Approx. 50 kWh/year

•Reduction of power consumption

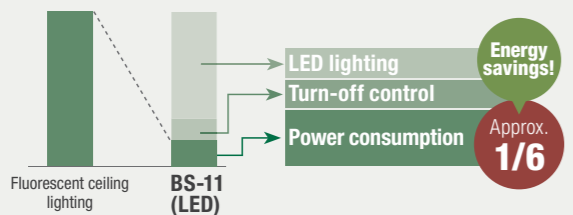

•Reduction of power consumption

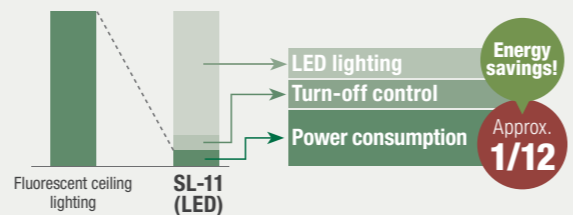

*1 These ceilings are not compliant with EN81-20/50 and SS550. In case of EN81-20/50, they can be used if the customer agrees.
*2 Comparison with 10-passenger model with fluorescent ceiling lighting. Results may differ depending on ceiling configuration and dimensions.
*3 Power consumption of fixture including lighting power supply.
*4 Rated service life of fixture including lighting power supply. Actual service life may vary depending on usage conditions.
*5 Varies depending on usage conditions.

Automatic turn-off of car lighting and fan

Standard

When the elevator is idle, the lighting and ventilation fan in the elevator are automatically turned off to conserve energy. Energy consumption is reduced by adopting LED lighting for the ceiling and by shortening the time until the lighting and fan turn off.

Regenerative system

Option

Making use of energy generated by the elevator

Making use of the energy generated by the elevator when traveling downwards with a heavy car load or upwards with a light car load, the traction mechanism acts as a power generator and transmits power back to the electrical network in the building.

Flow of regenerated power

Industrial power
Regenerated power

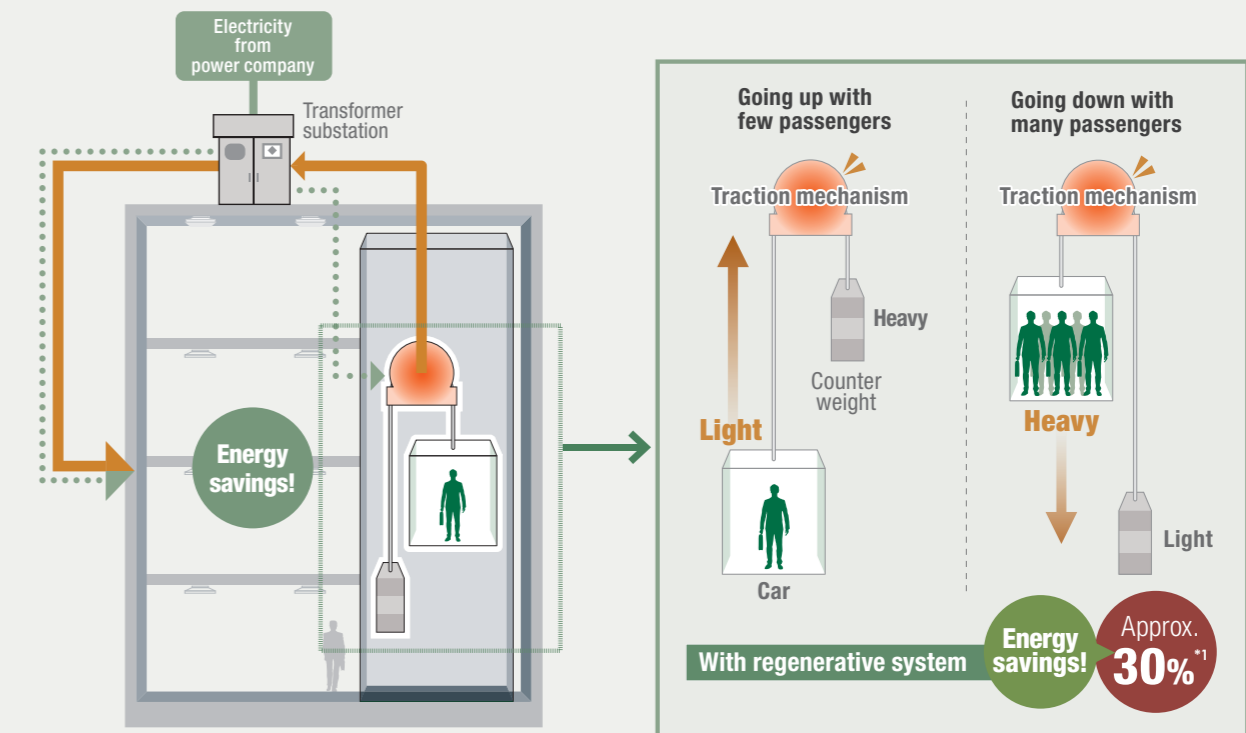

*1 In our model released in 2016, calculation of 30% energy saving is done based on no load in the lift car. The energy savings are calculated theoretically. Differs depending on usage conditions.

FI-600 Group control system

Option

Group control systems help reduce waiting time.

Shortening average waiting times and reducing the probability of a long wait^{*1} are the most important tasks of the group control system of an elevator. Hitachi continues to develop control algorithms to meet these needs. The FI-600 employs a new type of algorithm, future reference trajectory control. It helps reduce the probability of long waits.

*1 "Long wait" refers to a waiting time of over 60 seconds.

Summary of future reference trajectory control

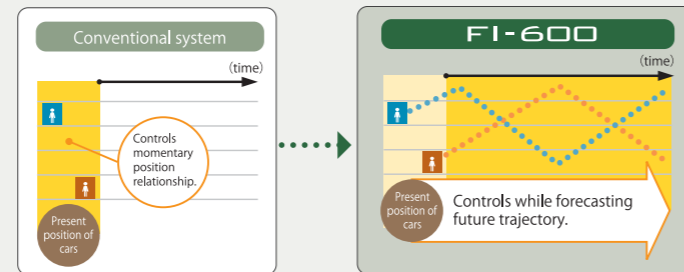

FIBEE Destination floor reservation system

Option

FIBEE leads passengers more reliably to their destination floors.

Hitachi has added a destination floor reservation system to the group control system. After each passenger registers their destination floor at the hall, they are informed ahead of time of the elevator they should use. This helps to reduce congestion in the hall.

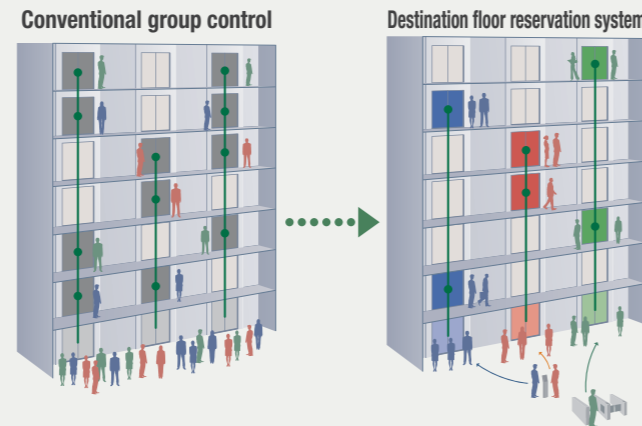

Using elevators with FIBEE

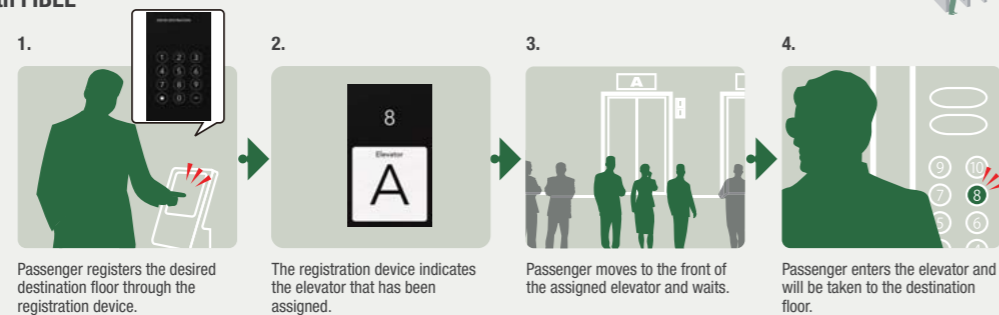

Destination floor registration device

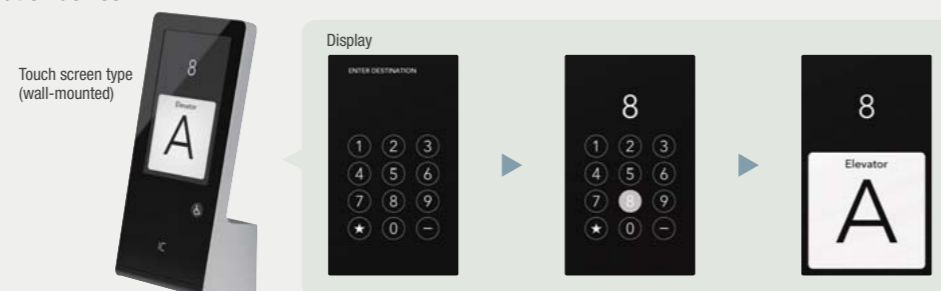

Ion generator

Option

Ion generator improves air quality.

An ion generator manufactured in Japan is mounted on top of the car. Nano-sized electrostatic atomized water particles work to improve air quality.



Notes
- Artist's conception.

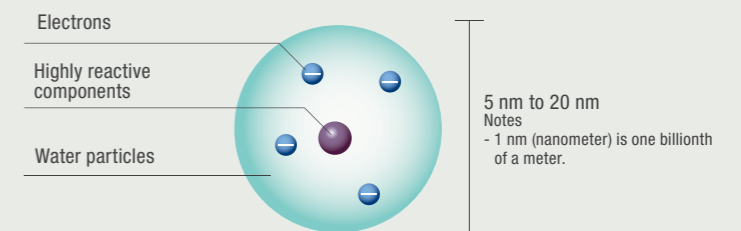

Elevator interior deodorizing test^{*1}

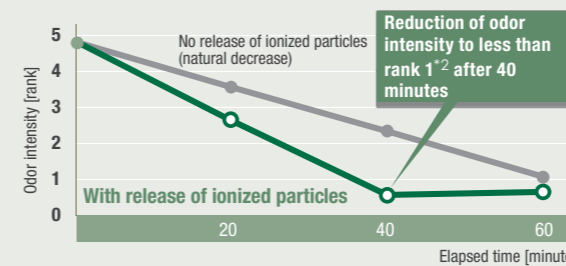

*1 Results after 40 minutes in test performed in (13-passenger) elevator measuring approx. 5.5 m³. Results may differ from those in actual usage space.
*2 Odor strength rank 1 is defined as "extremely weak odor that is hardly noticeable."

Testing organization: Hitachi Power Solutions Co., Ltd.
Testing method: Verification using six-rank odor intensity indication method in passenger elevator with 13-person capacity
Deodorizing method: Release of ionized particles
Subject: Methyl mercaptan was released and the change in its concentration was measured.

About ionized particles

The ionized particles released into the air come into contact with odor molecules and the OH radicals break down substances that cause odor.¹ Also, the ionized particles come into contact with allergens (pollen² and mites³), bacteria,⁴ and viruses,⁵ and the OH radicals denaturize their protein and suppress them.

1. Testing organization: Panasonic Corporation Product Analysis Center. Testing method: Direct exposure in 250-liter test space and verification using six-rank odor intensity indication method. Deodorizing method: Release of ionized particles. Subject: Accumulated cigarette odor. Test result: Odor intensity reduction of 0.8 after 30 minutes. Test number: E02-090313MH-01
2. Testing organization: Panasonic Corporation Product Analysis Center. Testing method: Direct exposure in 45-liter test space and measurement using ELISA method. Suppression method: Release of ionized particles. Subject: Allergen (pollen). Test result: Over 99% suppression after two hours. Test number: E02-080303IN-03
3. Testing organization: Panasonic Corporation Product Analysis Center. Testing method: Direct exposure in 45-liter test space and measurement using ELISA method. Suppression method: Release of ionized particles. Subject: Allergen (mites). Test result: Over 98% suppression after two hours. Test number: E02-080204IN-02
4. Testing organization: Kitasato Research Center for Environmental Science. Testing method: Direct exposure in 1-square-meter test vessel and measurement of bacteria count. Suppression method: Release of ionized particles. Subject: Airborne bacteria. Test result: Over 99% suppression after 20 minutes. Kitasato Biogenetic: 20_0154_1. Test performed for one type of bacteria only.
5. Testing organization: Kitasato Research Center for Environmental Science. Testing method: Direct exposure in 1-square-meter test vessel and measurement of virus count. Suppression method: Release of ionized particles. Subject: Airborne virus. Test result: Over 99% suppression after 90 minutes. Kitasato Biogenetic: 20_0154_1. Test performed for one type of virus only.

Notes
- The ionized particles suppress viruses, etc., but they are not guaranteed to prevent infection.
- The ion generator is not available in the following cases:
(1) When the ceiling is supplied by the customer.
(2) When the car internal depth is 1,250 mm or less.

Improved riding comfort

Standard

Measures such as control to suppress motor vibration and vibration-absorbing type guide shoes are utilized. These reduce noise and vibration when the elevator is in motion for a smooth and quiet ride.

Safety & Emergency

Door signal with multi-beam door sensor (Closing door alert)

Option

The door signal flashes to notify passengers when the door is starting to close.

The multi-beam door sensor is backed by a door signal that notifies passengers when the door is going to close. The LED on the edge of the door starts to blink about one second before the door starts to close. If the door close button in the elevator car is pressed, the LED starts blinking at the same time as the door starts to close.

Door signal



Notes
- Illustration shows simulated view of beams.

Micro-leveling

Standard

Automatic correction of elevator landing level when there is a level difference between car and floor. This improves safety when getting on and off the elevator.

Automatic rescue device for power failure

Option

In a power failure, the elevator switches to battery operation, and moves to the nearest floor.

When a power failure is detected, the drive power supply switches over to battery power, and the elevator automatically moves to the nearest floor and releases the passengers for safety. This lessens the worry of being trapped in the elevator that has stopped due to a power outage in a building with no private generator equipment.



Induction loop for hearing devices

Option

This function allows passengers with impaired hearing to use the elevator with confidence. If it is necessary to use the intercom in the elevator to communicate with people at other locations in an emergency, the passenger can select the "Telecoil mode" on their hearing aid or cochlear implant to have the audio signal from the intercom conveyed to them directly. The induction loop for hearing devices is an auxiliary device of the intercom that outputs audio signals magnetically, separately from the usual audio output. The induction loop for hearing devices covers an effective range of 0.5 meters from the operating panel, between 1.2 to 1.7 meters above the floor. Operating panel equipped with this function bears the "Induction loop" symbol.

Induction loop for hearing devices-Other locations

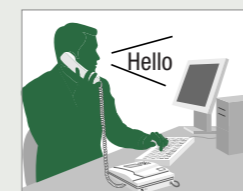

Other locations (e.g. Control room)

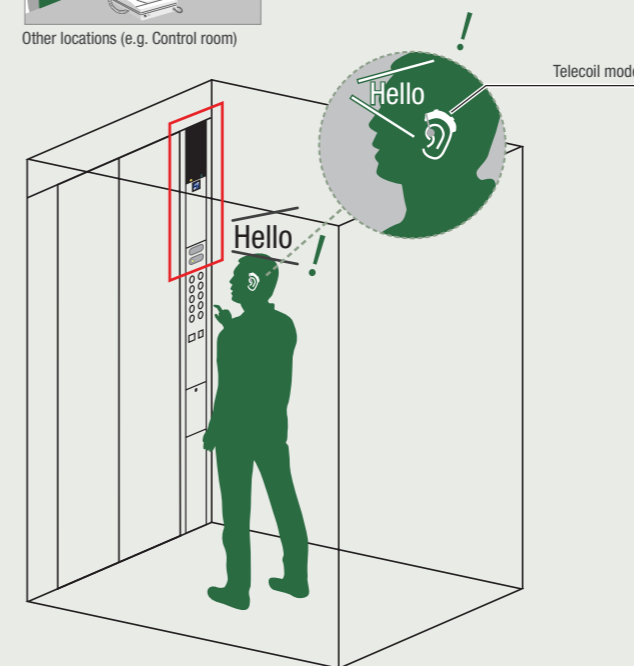

Operating panel with induction loop for hearing devices

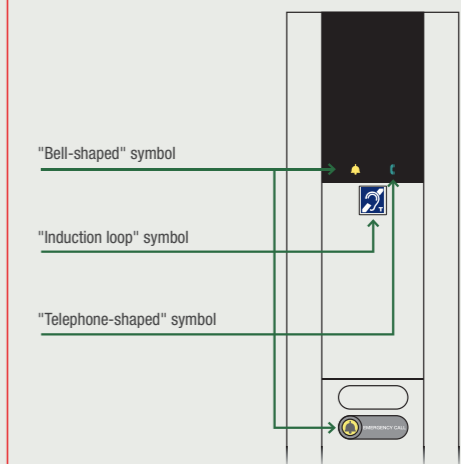

When this function is applied, the "Induction loop" symbol and the indicator light of the "Bell-shaped" symbol and the "Telephone-shaped" symbol are installed on the operating panel.



"Induction loop" symbol:
Not illuminated (Only mark)



"Bell-shaped" symbol:
The yellow graphical symbol blinks from the initiation of the alarm until the end of the alarm.



"Telephone-shaped" symbol:
The green graphical symbol illuminates during voice communication.

Notes
- An induction loop for hearing devices is used in combination with EN81-20/50.
- The illustration is an example.

Ceiling designs (Silkscreen print)

Option

By applying silk screening to the ceilings of SL-11 and DX-101, Hitachi ceiling designs coordinate your elevator with the building decor.

SL-11*1



SL-11-Oriental mosaic

SL-11-Cube

SL-11-Kaleidoscope

DX-101*1

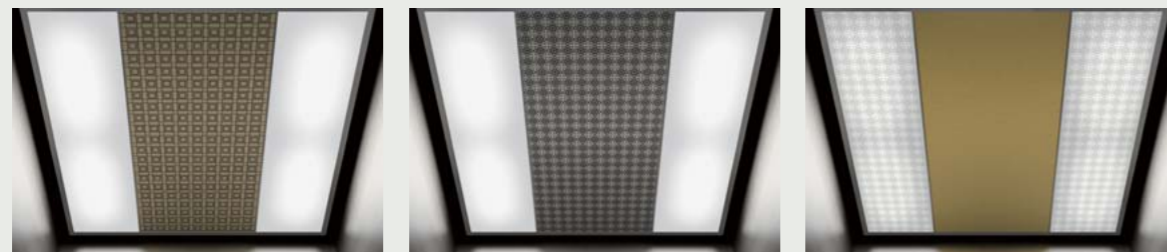

DX-101-Lattice

DX-101-Geometric star

DX-101-Arabesque

*1 These ceilings are not compliant with EN81-20/50 and SS550. In case of EN81-20/50, they can be used if the customer agrees.

Button designs

A wide range of buttons harmonizes with various building designs.

High-contrast plastic buttons

Standard

High-contrast and raised characters make numbers more legible. Button surfaces are rounded to make it easier to wipe them clean.



Stainless steel buttons

Option

Various stainless steel buttons are available.

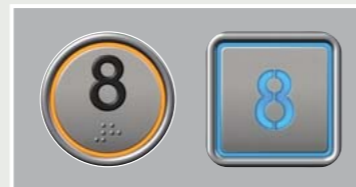

Interphone button

Standard

Designed for easy use in an emergency.

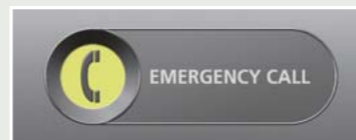

In-car LCD indicator

Option

The LCD indicator makes it easy to find necessary information.

An in-car indicator with an 8.4-inch color LCD is available. The LCD with wide angle improves visibility. It displays indications of the operating status, such as earthquake emergency operation, to the user.

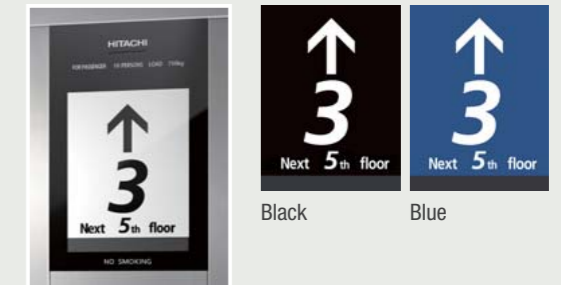

Black

Blue

Normal

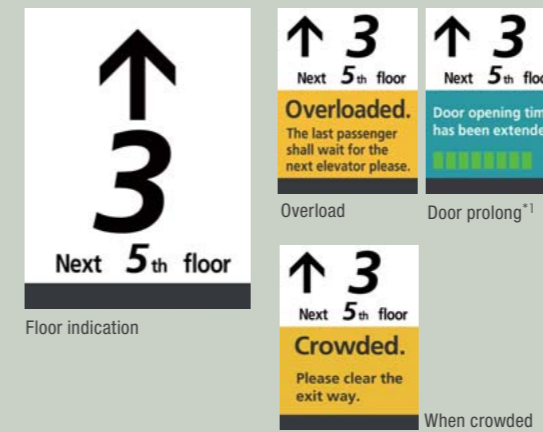

Emergency



*1 Display indications regarding operation during earthquakes, etc., require that the corresponding functions be installed.

Hall LCD indicator

Option

The hall LCD indicator displays abundant information in the hall.

A hall indicator with a 6.2-inch color LCD is available. Like the in-car LCD indicator, it displays indications of the operating status.



Earthquake*2

*2 Display indications regarding operation during earthquakes, etc., require that the corresponding functions be installed.





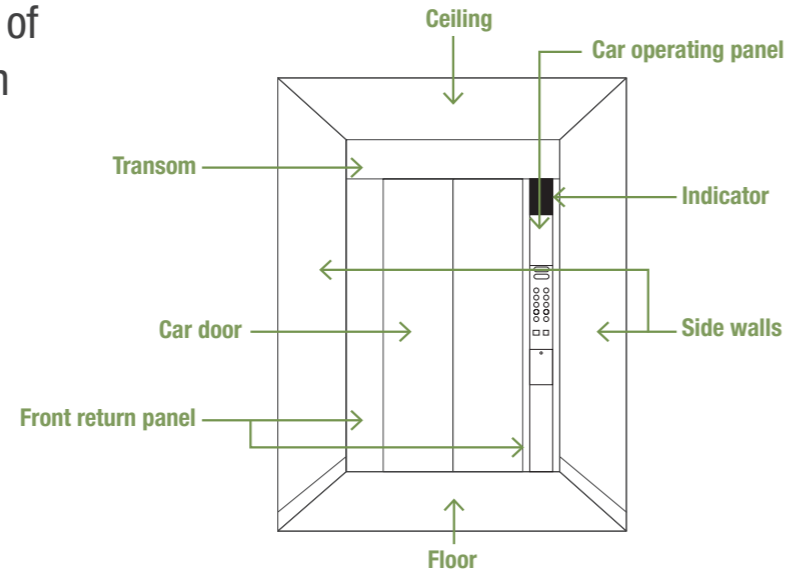

Recommended designs

Car designs

Choose from a wide range of design options to create an elevator look that matches your building.



Recommended designs Samples of designs created by a designer.

Stylish design	Chic design	Luxurious design
<ul style="list-style-type: none"> Office Commercial building 	<ul style="list-style-type: none"> Residence Hotel 	<ul style="list-style-type: none"> Commercial building Hotel
 <p>Ceiling: SL-series (SL-11-Kaleidoscope)*¹ 3 side walls: Decorated steel (Minamo white) Car door: Decorated steel (Minamo white)</p>	 <p>Ceiling: SL-series (SL-12) 3 side walls: Decorated steel (Mocha wood) Car door: Decorated steel (Mocha wood)</p>	 <p>Ceiling: EX-series (EX-11)*¹ 3 side walls: Decorated steel (Craft wood) Car door: Stainless steel non-directional hairline</p>
 <p>Ceiling: DX-series (DX-101-Lattice)*¹ 3 side walls: Colored stainless steel hairline Car door: Colored stainless steel hairline</p>	 <p>Ceiling: DX-series (DX-11) 3 side walls: Laminated plastic sheet (S261NT)*¹ Car door: Colored stainless steel hairline</p>	 <p>Ceiling: DX-series (DX-104) 3 side walls: Decorated steel (Mocha wood) Car door: Colored stainless steel hairline</p>

*1 These ceilings and LPS are not compliant with EN81-20/50 and SS550. In case of EN81-20/50, they can be used if the customer agrees.

Stylish design (for office)

Specifications	
Ceiling	SL-series (SL-11-Kaleidoscope)* ¹
3 side walls	Decorated steel (Minamo white)
Car door	Decorated steel (Minamo white)
Front return panel/Transom	Stainless steel hairline
Floor	Vinyl tile (S 442M)* ²
Indicator	LCD (8.4-inches)
Car operating panel	Stainless steel hairline

Notes
 - Illustrations show simulated views of elevator interiors. Actual illumination brightness and colors may differ.
 *1 The ceiling is not compliant with EN81-20/50 and SS550. In case of EN81-20/50, it can be used if the customer agrees.
 *2 The tile is not compliant with SS550.

Design variations



Stylish design (for commercial building)

Specifications	
Ceiling	DX-series (DX-101-Lattice)*1
3 side walls	Colored stainless steel hairline
Car door	Colored stainless steel hairline
Front return panel/Transom	Stainless steel mirror
Floor	Vinyl tile (S 672M)*2
Indicator	LCD (8.4-inches)
Car operating panel	Stainless steel mirror

Notes
 - Illustrations show simulated views of elevator interiors. Actual illumination brightness and colors may differ.
 *1 The ceiling is not compliant with EN81-20/50 and SS550. In case of EN81-20/50, it can be used if the customer agrees.
 *2 The tile is not compliant with SS550.

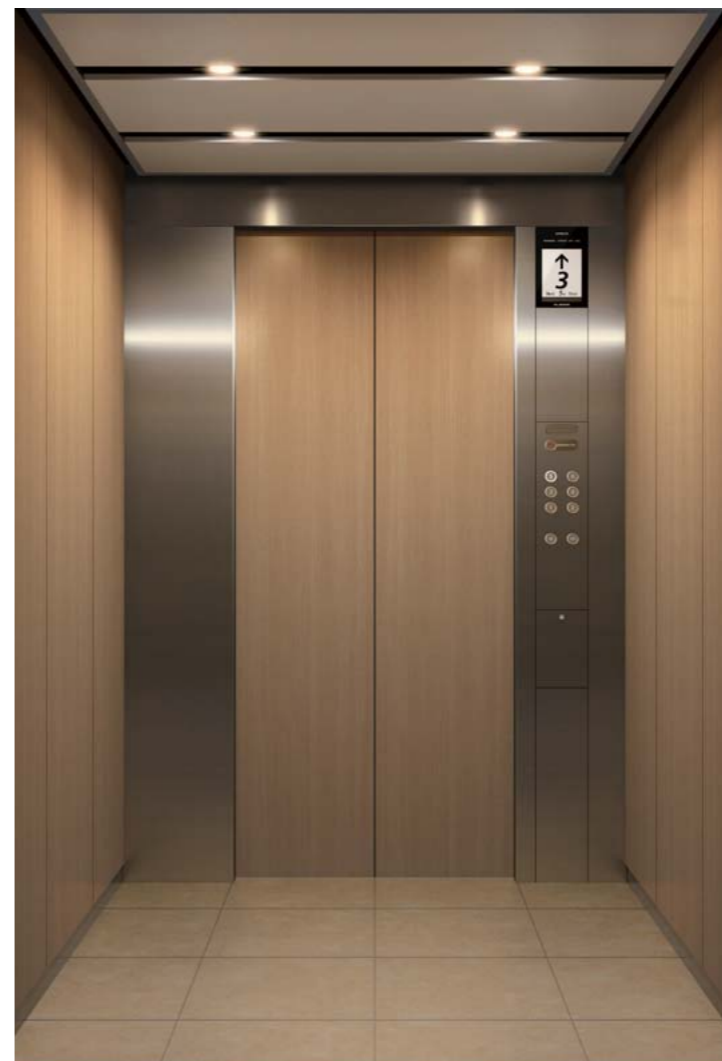

Chic design (for residential building)

Specifications	
Ceiling	SL-series (SL-12)
3 side walls	Decorated steel (Mocha wood)
Car door	Decorated steel (Mocha wood)
Front return panel/Transom	Stainless steel hairline
Floor	Vinyl tile (S 673M)*1
Indicator	LCD (8.4-inches)
Car operating panel	Stainless steel hairline



Chic design (for hotel)

Specifications	
Ceiling	DX-series (DX-11)
3 side walls	Laminated plastic sheet (5261NT)*2
Car door	Colored stainless steel hairline
Front return panel/Transom	Colored stainless steel hairline
Floor	Vinyl tile (S 671M)*1
Indicator	LCD (8.4-inches)
Car operating panel	Colored stainless steel hairline

Notes
 - Illustrations show simulated views of elevator interiors. Actual illumination brightness and colors may differ.
 *1 The tile is not compliant with SS550.
 *2 The LPS is not compliant with EN81-20/50 and SS550. In case of EN81-20/50, it can be used if the customer agrees.

Design variations



Luxurious design (for commercial building)

Specifications	
Ceiling	EX-series (EX-11)*1
3 side walls	Decorated steel (Craft wood)
Car door	Stainless steel non-directional hairline
Front return panel/Transom	Stainless steel non-directional hairline
Floor	Vinyl tile (S 629M)*2
Indicator	LCD (8.4-inches)
Car operating panel	Stainless steel non-directional hairline



Luxurious design (for hotel)

Specifications	
Ceiling	DX-series (DX-104)
3 side walls	Decorated steel (Mocha wood)
Car door	Colored stainless steel hairline
Front return panel/Transom	Colored stainless steel hairline
Floor	Vinyl tile (S 444M)*2
Indicator	LCD (8.4-inches)
Car operating panel	Colored stainless steel hairline

Notes
 - Illustrations show simulated views of elevator interiors. Actual illumination brightness and colors may differ.
 *1 The ceiling is not compliant with EN81-20/50 and SS550.
 In case of EN81-20/50, it can be used if the customer agrees.
 *2 The tile is not compliant with SS550.

Hall designs

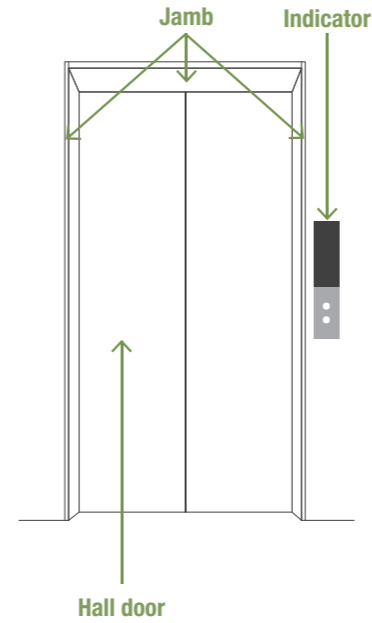

AS-1X (2PCO)

Standard

Jamb: Stainless steel hairline
Hall door: Stainless steel hairline
Indicator: Dot-matrix

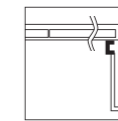

SS-1X (2PCO)

Option

Jamb: Stainless steel hairline
Hall door: Stainless steel hairline
Indicator: Dot-matrix

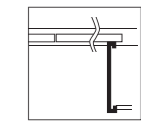

TS-1X (2PCO)

Option

Jamb: Stainless steel hairline
Hall door: Stainless steel hairline etching (SD-1038)
Indicator: LCD

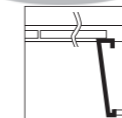

SL-2X (2PCO)

Option

Jamb: Stainless hairline
Hall door: Stainless steel hairline
Indicator: LCD

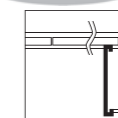

TL-2X (2PCO)

Option

Jamb: Stainless steel hairline
Hall door: Stainless steel hairline
Indicator: LCD

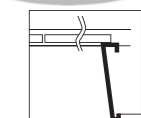

Notes
 - Illustrations show simulated views of elevator interiors. Actual illumination brightness and colors may differ.

Ceilings and Handrails

Ceilings Standard

Standard

BS-11*1 **Center:** Milky white acrylic*2
Surrounding: Painted steel (White)



Select

Option

SL-11*1 **Entire surface:** Milky white acrylic
Surrounding: Extruded aluminum

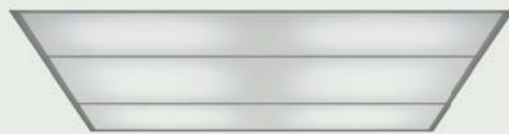

SL-12 **Entire surface:** Painted steel (White)
Illumination slits: Painted steel (Black)
Surrounding: Extruded aluminum



Variations of SL-11

Silkscreen print

Option

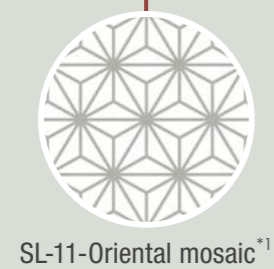
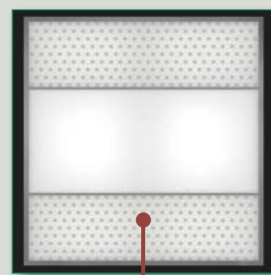

SL-11-Oriental mosaic*1

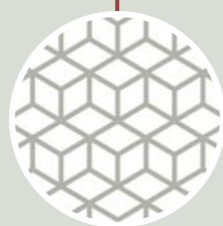
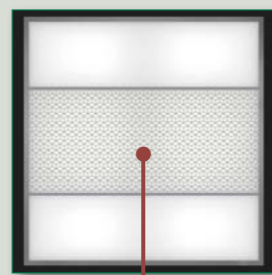

SL-11-Cube*1

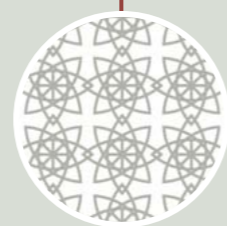
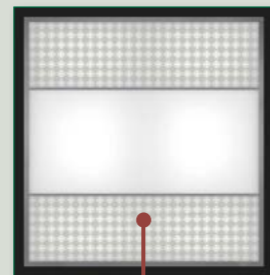

SL-11-Kaleidoscope*1

Notes
- It is also possible to use ceiling materials supplied and installed by the customer.
- Depending on applicable regulations, car top emergency trap door may be required.
*1 These ceilings are not compliant with EN81-20/50 and SS550. In case of EN81-20/50, they can be used if the customer agrees.
*2 For some car sizes, there are two milky white acrylic options.

Deluxe

Option

DX-101*1

Center: Painted steel (White)
Both sides: Milky white acrylic
Surrounding: Extruded aluminum



DX-11

Center: Painted steel (White)
Indirect lighting
Both sides: Painted steel (White)
Down light
Surrounding: Extruded aluminum



DX-104

Entire surface: Painted steel (Black)
Down light
Trim: Stainless steel

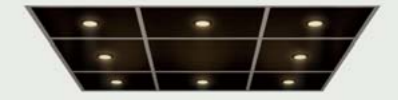

Variations of DX-101

Silkscreen print

Option

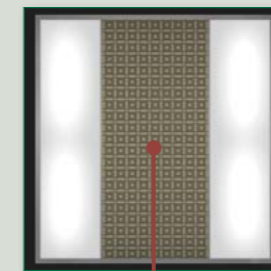

DX-101-Lattice*1

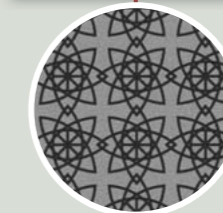
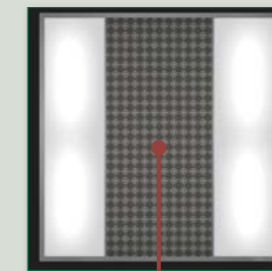

DX-101-Geometric star*1

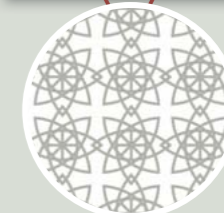
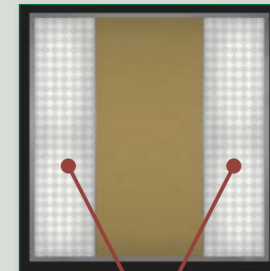

DX-101-Arabesque*1

Premium

Option

EX-11*1 **Entire surface:** Glass fiber cloth



Notes
- It is also possible to use ceiling materials supplied and installed by the customer.
- Depending on applicable regulations, car top emergency trap door may be required.
*1 These ceilings are not compliant with EN81-20/50 and SS550. In case of EN81-20/50, they can be used if the customer agrees.

Handrails

Option



Round pipe type
(stainless steel hairline)
Diameter: 32 mm



Flat type
(aluminum)
Width: 90 mm



Flat type
(stainless steel hairline)
Width: 90 mm



Flat type
(stainless steel hairline)
Width: 50 mm

Notes
- Illustrations show simulated views of handrail designs. Actual illumination brightness and colors may differ.

Operating panels and indicators

Car operating panels

Stainless steel cover plate

Indicator type
(Dot-matrix) (LCD)
Standard **Option**

Car position indicators (LCD) **Option**
In addition to white, you can select black or blue as the background color.

White (standard color) Black Blue

The car operating panel is installed on the side wall in the following cases:
 • Front return panel width < 300 mm
 • Number of stop floors ≥ 25 floors

Indicator type
(Dot-matrix) (LCD)
Standard **Option**

OPV/D OPV/L OPW/D OPW/L

Horizontal operating panels **Option**

Stainless steel cover plate

Without indicator With indicator

For wheelchair use For wheelchair use

Car button types

Plastic **Standard** **Stainless steel hairline** **Option**

P14F-UL UB15R-1 UB15R-2 UB15R-3 UB15R-4

Interphone button*² UB15S-1 UB15S-2 UB15S-3 UB15S-4

Interphone button*²

Illumination colors^{*1}

Red White Yellow Blue

*1 Illumination colors are only applicable for stainless steel hairline buttons.
 *2 Only circular interphone buttons are available. Other specifications (illumination color, Braille, etc.) of the interphone button change according to each floor button. Please consult Hitachi or a local agent if other specifications are required.

Hall operating panels

Stainless steel cover plate

Incorporated type (Dot-matrix) **Standard** **Incorporated type (LCD)** **Option**

VIB-14B/D VIB-14B/L

Separate type **Option** **Separate type (for wheelchair use)** **Option**

HBC

Hall lanterns **Option**

Stainless steel cover plate

Square lanterns (LED) Round lanterns (LED)

HLC-304*² HLC-303*²

Triangle lanterns (horizontal type) (LED)

HLS-025S2*²

Triangle lanterns with dot-matrix indicator (LED)

HLS-025SD2*²

Car position indicators (LCD)

In addition to white, you can select black or blue as the background color.

White (standard color) Black Blue

Horizontal indicators **Option**

Stainless steel cover plate

Dot-matrix

HF-119

LCD^{*1}

HF-CL11

Hall button types

Plastic **Standard** **Stainless steel hairline** **Option**

P14F-UL UB15R-1 UB15R-2 UB15R-3 UB15R-4

UB15S-1 UB15S-2 UB15S-3 UB15S-4

Illumination colors^{*3}

Red White Yellow Blue

*1 The LCD backlight can be changed from white to black or blue. (Standard color: White)
 *2 Stainless steel non-directional hairline cover is available. (Option)
 The lantern illumination color can be changed to white. (Standard illumination color: Umber)
 *3 Illumination colors are only applicable for stainless steel hairline buttons.

Materials

Car



Hall



A [Car] Front wall / Transom

Stainless steel



Colored stainless steel (Option)

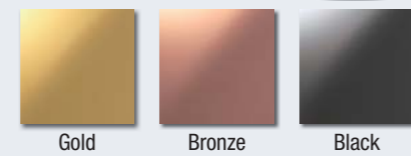

* Colored stainless steel is available for hairline and mirror options.

Stainless steel hairline etching and mirror etching (Option)

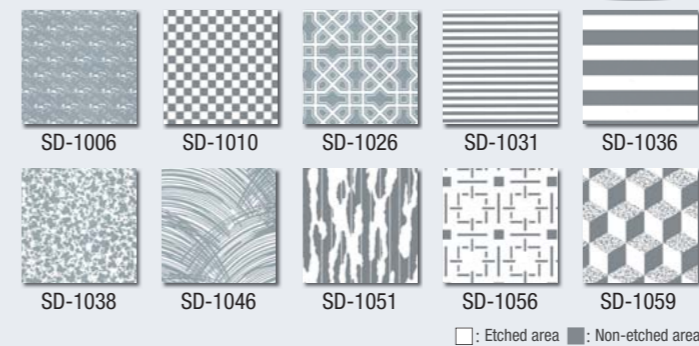

Decorated steel (Option)

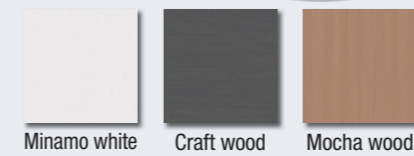

B [Car] Door / 3 side walls [Hall] Door

Stainless steel



Colored stainless steel (Option)

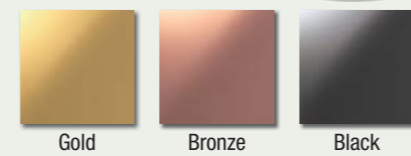

* Colored stainless steel is available for hairline and mirror options.

Stainless steel hairline etching and mirror etching (Option)

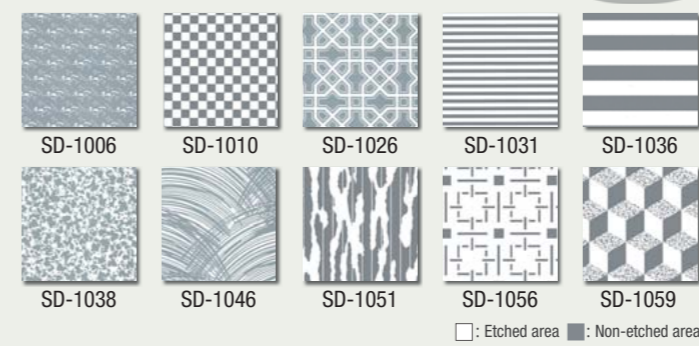

Decorated steel (Option)

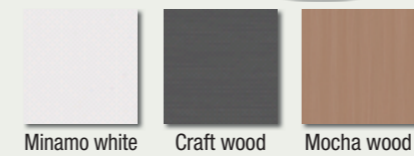

* Decorated steel cannot be used for the hall door.

Laminated plastic sheet (LPS)^{*2} (Option)



D [Car] Floor

Vinyl tile^{*3} (Standard)



C [Hall] Jamb / Transom

Stainless steel



Colored stainless steel (Option)

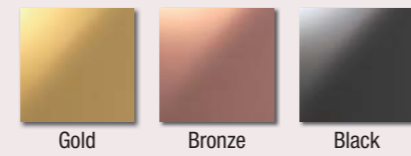

* Colored stainless steel is available for hairline and mirror options.

Stainless steel hairline etching and mirror etching^{*6} (Option)

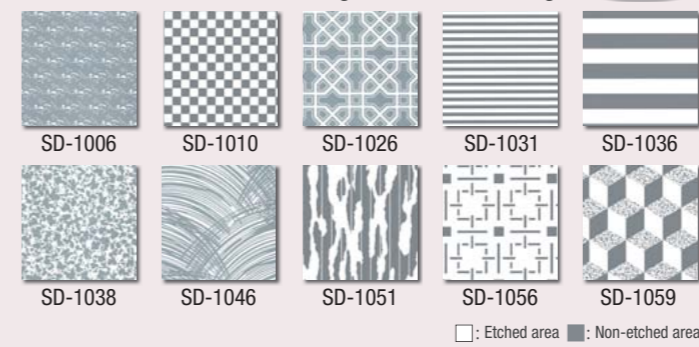

* Stainless steel hairline etching and mirror etching cannot be used for the hall jamb.

- Notes
- It is also possible to use floor materials supplied by the customer.
 - The colors printed in the catalog may differ slightly from the actual colors.
 - *1 SUS430 (Standard), SUS304 (Option)
 - *2 These LPS are not compliant with EN81-20/50 and SS550. In case of EN81-20/50, they can be used if the customer agrees.
 - *3 These vinyl tiles are not compliant with SS550.
 - *4 These vinyl tiles are compliant with EN81-20/50.
 - *5 These vinyl tiles are not compliant with EN81-20/50, but they can be used if the customer agrees.
 - *6 Stainless steel hairline etching and mirror etching can only be applied to SL-2X and TL-2X.

Design variations

Car design variations

● : Standard / ○ : Option

No.	Item	Finishes / Types	Passenger Service		
1	Ceiling ^{*1}	Standard (BS-11) ^{*2}	●		
2		Select (SL-11) ^{*2} (SL-11-Oriental mosaic) ^{*2} (SL-11-Cube) ^{*2} (SL-11-Kaleidoscope) ^{*2} (SL-12)	○		
3		Deluxe (DX-101) ^{*2} (DX-101-Lattice) ^{*2} (DX-101-Geometric star) ^{*2} (DX-101-Arabesque) ^{*2} (DX-11) (DX-104)	○		
4		Premium (EX-11) ^{*2}	○		
5	Car door / 3 side walls	Stainless steel hairline	●		
6		Colored stainless steel hairline (Gold, Bronze, Black)	○		
7		Stainless steel hairline etching	○		
8		Colored stainless steel hairline etching (Gold, Bronze, Black)	○		
9		Stainless steel mirror	○		
10		Colored stainless steel mirror (Gold, Bronze, Black)	○		
11		Stainless steel mirror etching	○		
12		Colored stainless steel mirror etching (Gold, Bronze, Black)	○		
13		Stainless steel non-directional hairline	○		
14		Decorated steel ^{*3}	○		
15		Laminated plastic sheet ^{*4 *5} (7170UN) (2726NT) (5261NT) (7171UN) (7158UN) (7157UN) (0869NT) (8834NT)	○		
16		Rust proof coating steel	○		
17		Front wall and transom	Stainless steel hairline	●	
18			Colored stainless steel hairline (Gold, Bronze, Black)	○	
19	Stainless steel hairline etching		○		
20	Colored stainless steel hairline etching (Gold, Bronze, Black)		○		
21	Stainless steel mirror		○		
22	Colored stainless steel mirror (Gold, Bronze, Black)		○		
23	Stainless steel mirror etching		○		
24	Colored stainless steel mirror etching (Gold, Bronze, Black)		○		
25	Stainless steel non-directional hairline		○		
26	Decorated steel ^{*3}		○		
27	Rust proof coating steel	○			
28	Kick plate	Stainless steel hairline	●		
29		Stainless steel non-directional hairline	○		
30	Sill	Extruded hard aluminum	●		
31		Stainless steel	○		
32	Floor ^{*1 *6}	Compliant with EN81-20/50 ^{*7} Vinyl tile (S 442M) (S 444M) (S 629M) (S 670M) (S 671M) (S 672M) (S 673M)	●		
33		Not compliant with EN81-20/50 ^{*8} Vinyl tile (P 0803) (P 0807)	●		
34	Handrail	Round type	stainless steel hairline	Diameter: 32 mm (one row)	○
35				Flat type	stainless steel hairline
36		Width: 90 mm (one row)	○		
37		Width: 90 mm (two rows)	○		
38		Width: 90 mm (one row)	○		
39		aluminum	Width: 90 mm (two rows)	○	
40	Car operating panel		Vertical ^{*9}	Dot-matrix indicator (OPV/D, OPW/D)	●
41		LCD indicator (OPV/L, OPW/L) (White, Black, Blue)		○	
42		Horizontal	Without indicator	○	
43			Dot-matrix indicator	○	
44			Horizontal for wheelchair	Without indicator	○
45	Dot-matrix indicator	○			
46	Car operating panel cover plate	Stainless steel hairline	●		
47		Stainless steel mirror	○		
48		Stainless steel non-directional hairline	○		
49		Plastic (P14F-UL)	●		
50	Button type	Stainless steel hairline ^{*10} (UB15R-1) (UB15R-2) (UB15R-3) (UB15R-4) (UB15S-1) (UB15S-2) (UB15S-3) (UB15S-4)	○		

*1 It is also possible to use materials supplied and installed by the customer.
 *2 These ceilings are not compliant with EN81-20/50 and SS550. In case of EN81-20/50, they can be used if the customer agrees.
 *3 Decorated steel is available in the following cases:
 (1) Ceiling height (CH) with respect to each ceiling type:
 BS-11, BY OTHERS: CH ≤ 2,300 mm
 SL-11, 12, DX-11, 101: CH ≤ 2,250 mm
 DX-104, EX-11: Not available
 (2) Entrance height (EH) ≤ 2,100 mm
 *4 The LPS comes with a stainless steel hairline trim edge.
 *5 These LPS are not compliant with EN81-20/50 and SS550. In case of EN81-20/50, they can be used if the customer agrees.
 *6 These vinyl tiles are not compliant with SS550.
 *7 These vinyl tiles are compliant with EN81-20/50.
 *8 These vinyl tiles are not compliant with EN81-20/50, but they can be used if the customer agrees.
 *9 Depending on the size of the car, may be mounted on a side wall.
 *10 The available button illumination colors are yellow, red, white, and blue.

Hall design variations

● : Standard / ○ : Option

No.	Item	Finishes / Types	Passenger Service	
1	Jamb type	AS-1X	●	
2		SS-1X	○	
3		TS-1X	○	
4		SL-2X	○	
5		TL-2X	○	
6	Jamb finish	Stainless steel hairline	●	
7		Colored stainless steel hairline	○	
8		Stainless steel mirror	○	
9		Colored stainless steel mirror	○	
10		Stainless steel non-directional hairline	○	
11		Rust proof coating steel	○	
12	Transom finish	Stainless steel hairline	●	
13		Colored stainless steel hairline (Gold, Bronze, Black)	○	
14		Stainless steel hairline etching	○	
15		Colored stainless steel hairline etching (Gold, Bronze, Black)	○	
16		Stainless steel mirror	○	
17		Colored stainless steel mirror (Gold, Bronze, Black)	○	
18		Stainless steel mirror etching	○	
19		Colored stainless steel mirror etching (Gold, Bronze, Black)	○	
20		Stainless steel non-directional hairline	○	
21		Rust proof coating steel	○	
22	Hall door	Stainless steel hairline	●	
23		Colored stainless steel hairline (Gold, Bronze, Black)	○	
24		Stainless steel hairline etching	○	
25		Colored stainless steel hairline etching (Gold, Bronze, Black)	○	
26		Stainless steel mirror	○	
27		Colored stainless steel mirror (Gold, Bronze, Black)	○	
28		Stainless steel mirror etching	○	
29		Colored stainless steel mirror etching (Gold, Bronze, Black)	○	
30		Stainless steel non-directional hairline	○	
31		Laminated plastic sheet ^{*1} (7170UN) (2726NT) (5261NT) (7171UN) (7158UN) (7157UN) (0869NT) (8834NT)	○	
32		Rust proof coating steel	○	
33	Sill	Extruded hard aluminum	●	
34		Stainless steel	○	
35	Hall button cover plate	Incorporated indicator	Stainless steel hairline	●
36			Stainless steel mirror	○
37			Stainless steel non-directional hairline	○
38		Separate indicator	Stainless steel hairline	○
39			Stainless steel mirror	○
40			Stainless steel non-directional hairline	○
41	Hall button cover plate for wheelchair use	Incorporated indicator	Stainless steel hairline	○
42			Stainless steel mirror	○
44		Separate indicator	Stainless steel non-directional hairline	○
45			Stainless steel hairline	○
46	Stainless steel non-directional hairline	○		
47	Indicator	Vertical	Dot-matrix	●
48			LCD (White, Black, Blue)	○
49		Horizontal	Dot-matrix (HF-119)	○
50	LCD (HF-CL11) (White, Black, Blue)		○	
51	Horizontal indicator cover plate	Stainless steel hairline	○	
52		Stainless steel mirror	○	
53		Stainless steel non-directional hairline	○	
54	Button type	Plastic (P14F-UL)	●	
55		Stainless steel hairline ^{*2} (UB15R-1) (UB15R-2) (UB15R-3) (UB15R-4) (UB15S-1) (UB15S-2) (UB15S-3) (UB15S-4)	○	
56	Lantern	Vertical	Square lanterns (HLC-304) (Orange, White)	○
57			Round lanterns (HLC-303) (Orange, White)	○
58		Horizontal	Triangle lanterns (HLS-025S2)	○
59			Triangle lanterns with dot-matrix indicator (HLS-025SD2)	○
60	Lantern cover plate	Stainless steel hairline	○	
61		Stainless steel mirror	○	
62		Stainless steel non-directional hairline	○	

*1 The LPS comes with a stainless steel hairline trim edge and cannot be used for the hall door when fire rated doors are required.
 *2 The available button illumination colors are yellow, red, white, and blue.

Functions

● : Standard / ○ : Option

No.	Name	Description	Passenger Service
Operating systems			
1	Simplex collective control	This is a fully automatic operation used for a single elevator system. Hall calls in the direction in which the elevator is travelling are responded to sequentially and when all calls in that direction are cleared, calls in the opposite direction are responded to. When there are no more calls, the elevator will stop at the last floor served.	●
2	Duplex collective control	This is a fully automatic operation used for a two-elevator system. Hall calls are responded to by whichever elevator that can serve the hall call faster. When there are no more calls, one of the elevators will stand by at the stand by floor while the other elevator stays at the last floor served.	○
3	Group control	FIBEE Allows the passenger to preselect the destination floor on the destination floor panel installed at the landing hall. This reduces button operations to one, improving the operability.	○
4		FI-10 This is a simplified group control system used to operate three or four elevators. The system provides a ring control to allocate the elevator car closed to the floor where a new hall call is registered.	○
5		FI-100 This is a group control system used to operate three to six elevators in a medium-sized building. This control system uses "reference-trajectory control", which is based on the theory used in the highest model of the "future reference-trajectory control".	○
6		FI-600 This is a group control system used to operate three to eight elevators in a large-sized building. This control system consists of three smart systems; "future reference-trajectory control", "learning system" and "intelligent system".	○
7	Down collective control	For this system, all floors have "down" call buttons only, except for the stand by floor, where there is "up" call button only. The other operations are the same as in selective-collective and duplex selective-collective operations.	○
Service functions			
1	Automatic return function	After all the calls have been served, the elevator will return to the stand by floor for stand by.	○*1
2	Attendant operation	For this system, the stop floor is manually set by an attendant, such as in a department store.	○
3	Independent operation	This operation system is used when there is a need to serve special passengers. Under this operation, all hall calls are disabled for the elevator and it is reserved for exclusive use of the special passengers.	○
4	Parking operation	The elevator can be parked at the parking floor by a key switch.	○*2
5	Rush-hour schedule operation	All the elevators will automatically return to the stand by floor, after serving the last call during this preset rush-hour timing.	○
6	Separated simplex operation	When duplex collective control or group control is used, a selector switch on the control panel is used to switch between parallel operation and independent operation.	○
7	Interphone system	An interphone system is provided for emergency communication between the elevator and the master unit in the supervisory panel, etc.	●
8	Floor lock-out operation	Specific service floors can be locked-out by activating a switch.	○
9	Temporary call registration of certain restricted floor	By inputting a pre-programmed code using the car operating board floor buttons, passengers can gain access to certain restricted floors.	○
10	Door nudging operation	When the door has been open for a certain period of time, a buzzer sounds and the door forcibly closes.	○

*1 Included in the standard configuration when duplex collective control or group control is selected.

*2 Included in the standard specifications for Thailand, Laos, Myanmar, and Cambodia.

● : Standard / ○ : Option

No.	Name	Description	Passenger Service
Safety functions			
1	Abnormal speed protection function	In the event that the elevator is moving downwards at an abnormally high speed, the brakes will be automatically engaged and the elevator will cease operation.	●
2	Out of door-open zone alarm	In the event that the elevator stops out of the door-open zone of a selected floor, doors will not open, and an alarm will sound in the elevator.	●
3	Rescue operation	When the elevator stops out of the door-open zone, it will move to the nearest floor at slow speed to release passengers.	●
4	Door safety return system	In the event of door overload, such as when passengers get their fingers, hands or personal belongings caught in the door, this system automatically senses this and either re-closes or re-opens the doors to prevent injury.	●
5	Micro-leveling	Automatic correction of elevator landing level when there is a level difference between car and floor.	●
6	Car emergency lighting	In the event of a power failure, an emergency light inside the elevator will be automatically activated.	●
7	Emergency Battery Operated Power Supply (EBOPS / UPS)*1	In the event of a power failure, this emergency supply allows the operation of a light and alarm bell, etc.	○
8	Multi-beam door sensor	In the event that the beam paths are obstructed, this sensor, installed at the edge of the doors, will keep the doors open.	●
9	Door signal with multi-beam door sensor	In addition to the multi-beam door sensor, the safety shoe is equipped with a signal that indicates when the doors are starting to close. (2PCO: Both sides, 2S2P: One side)	○
10	Door safety edge	Mechanical safety units are installed on both sides (2PCO) or one side (2S2P) of the elevator doors. In the event of passengers coming into contact with the safety edges of closing doors, the doors will immediately reopen.	○
Accessibility			
1	Car floor button flashing	The registered car destination floor button flashes when the car approaches the floor.	●
2	Braille plate	Braille plates are fixed next to the operation buttons in the car and hall.	○
3	Sound button	An electronic tone sounds when the buttons are pressed to confirm call registration.	○
4	Induction loop for hearing devices*2	This function allows a passenger to select the "Telecoil mode" on their hearing aid or cochlear implant to communicate with people at other locations via the intercom in an emergency. It conveys the audio signal from the intercom directly to the passenger's hearing aid or cochlear implant.	○
Security functions			
1	Intelligent operation security system by card reader (by others)	This function allows controlled access to certain floor by means of ID cards. Note: ID card-reader system is to be provided and installed by others. Interfacing shall be by means of dry (voltage-free) contacts.	○
2	CCTV (camera by others, coaxial cable by Hitachi)	This system enables the security personnel to monitor inside the elevator car. This will be effective in preventing criminal and mischievous acts inside the elevator car. (CCTV system, including wiring, is to be supplied by others.)	○
Information functions			
1	IC auto announcement (English / Thai / Malay / Mandarin / Cantonese / Portuguese)	Preset standard messages are announced to the passengers.	○
2	Public address speaker	A speaker for background music and public announcements for the building can be installed in the elevator. (Music and announcement systems, including wiring, are to be provided by others.)	○
3	Arrival audio signal	An electrical chime (located at the top and bottom of the elevator) will sound just before the arrival of the elevator.	○
Energy-saving functions			
1	Regenerative system	When traveling downwards with a heavy car load or upwards with a light car load, the traction machine acts as a power generator to transmit power back to the electrical network in the building.	○
2	Automatic turn-off of elevator light and fan	In the event that the elevator is not in use, the light and ventilation fan in the elevator are automatically turned off to conserve energy.	●

*1 EBOPS (UPS) is provided as a standard specification when it is required by regulations.

*2 Induction loop for hearing devices is used in combination with EN81-20/50.

● : Standard / ○ : Option

No.	Name	Description	Passenger Service
User services			
1	Observation	The walls of the elevator are equipped with windows, giving the elevator interior a more open feel.	○
2	Door open time adjustment	The duration of the door open timing is tailored to usage conditions, substantially improving operational efficiency.	●
3	Door open prolong button	In the event that this button on the car operation board is pressed, the elevator doors remain open for a pre-set period of time.	○
4	Automatic bypass operation	In the event that the elevator is fully loaded, this operation will not respond to any hall calls and will only respond to the car calls.	○
5	Mischievous call cancellation	In the event that a large number of calls is registered by a small number of passengers, the calls are determined to be mischievous and will be automatically cancelled upon responding to the next call. This eliminates unnecessary stops.	●
6	Floor "deselect" function	This function allows passengers to cancel the selection of a floor which is accidentally pressed by pressing the button again. (This eliminates unnecessary stops.)	●
7	Supervisory panel	This panel provides various supervisory operations, including communication and status monitoring.	○
8	Elevator monitoring system (EMS)	This system shows the real time situation of the elevators such as the elevator position, movement direction and abnormal operation on the PC (Personal Computer) display. It is also possible to turn on/off the elevators and change the service floors of the elevators using the PC.	○
9	Ion generator*1	A device that generates ionic microparticles enclosed in water is mounted on top of the car to ensure pleasant air quality inside the elevator.	○
10	Air conditioner	An evaporative-type cooling unit eliminates the need for pit drainage. This enhances comfort inside the elevator.	○
Emergency operations			
1	Earthquake emergency operation	In the event that an earthquake is detected, the elevator will stop at the nearest floor.	○
2	Earthquake emergency operation with primary wave sensor	When primary wave of an earthquake is detected, the elevator moves to the nearest floor and stops.	○
3	Fire emergency operation	In the event of fire, the elevator is automatically brought to the designated floor where it remains inoperative for passengers' safety. EN81-73 is available if required.	○
4	Automatic rescue device for power failure	In the event of power failure, this system automatically switches to battery power to bring the elevator to the nearest floor.	○
5	Emergency operation for power failure	In the event of building power failure, the elevator can be operated by the building standby generator to move the elevator to the designated floor. (Automatic / Automatic and manual)	○
6	Pit flood operation	Elevator operation is paused when pit flooding is detected.	○
7	Fireman operation	In the event that the fireman switch is turned on, the elevator returns to the designated floor and will be ready for firemen's use.	○
Other functions			
1	Counterweight safety	A safety device is installed on the counterweight to maintain the rails and prevent falling.	○
2	Through door	Doors are installed on both sides of the elevator.	○
3	Freight condition of service lift	The elevator floor is reinforced to enable it to accommodate a larger volume of freight at once.	○
4	Over voltage detection device	When an abnormal increase in power supply to the elevator system is detected, the power supply will be cut off to prevent damage to the elevator equipment.	○
5	Maintenance operation	Elevator operates at lower speed during maintenance.	●
6	Overload detection system	In the event of overloading, this system will activate an audio / visual signal to prevent the elevator from moving.	●
7	Nearest landing door operation	In the unlikely event of temporary trouble during operation, the elevator automatically goes to the nearest floor at a low speed and doors will open to prevent passengers from being trapped inside.	●
8	Hook for protection sheet	The 3 side walls are equipped with hooks to facilitate mounting of protective mats.	○
9	Checker plate	A steel plate is affixed to the floor of the elevator.	○
10	Protection plate (stainless steel hairline) (H = 300 mm)	Protective stainless steel plates are installed to protect the area extending upward 300 mm from the bottom edge of three-side walls in car.	○
11	Protection plate (stainless steel hairline) (H = 1200 mm)	Protective stainless steel plates are installed to protect the area extending upward 1,200 mm from the bottom edge of three-side walls in car.	○
12	Sub-operating panel	Additional floor selection and door open/close buttons are located on the side opposite the main operating panel.	○
13	Keypad sub car-operating board	In order to comply with the barrier-free code, especially for high-rise buildings, individual car call buttons can be replaced by a keypad system.	○
14	Fire rated door*2	2 hours fire rated landing doors are available where required.	○
15	Fire insulation door(For Malaysia only)	2 hours fire insulation landing doors are available where required.	○
16	Emergency landing door	If there is a long distance between floors, doors are installed in a location where the elevator can stop automatically in an emergency.	○
17	Switch for emergency exit	A switch stops the elevator when the emergency exit door is opened.	○
18	Switch for door-machine inspection opening	A switch stops the elevator when the door of the door-machine inspection opening is opened.	○
19	Painted equipment inside hoistway	Equipment in the hoistway is painted black.	○
20	Electromagnetic compatibility (EMC)	Electromagnetic compatibility function in response to EN81-20/50, etc.	○
21	Interfacing to building management system	This interfacing shall be done by means of electrical dry contact with the building management system for their monitoring.	○

*1 The ion generator is not available in the following cases:
 (1) When the ceiling is supplied by the customer.
 (2) When the car internal depth is 1,250 mm or less.
 *2 Fire rated door is provided as a standard specification when it is required by regulations.

Dimensions

- Building structure (by other contractors)
- Wall and floor finishing (by other contractors)
- Grouting (by other contractors)

AS-1X (2PCO) Standard

(unit: mm)

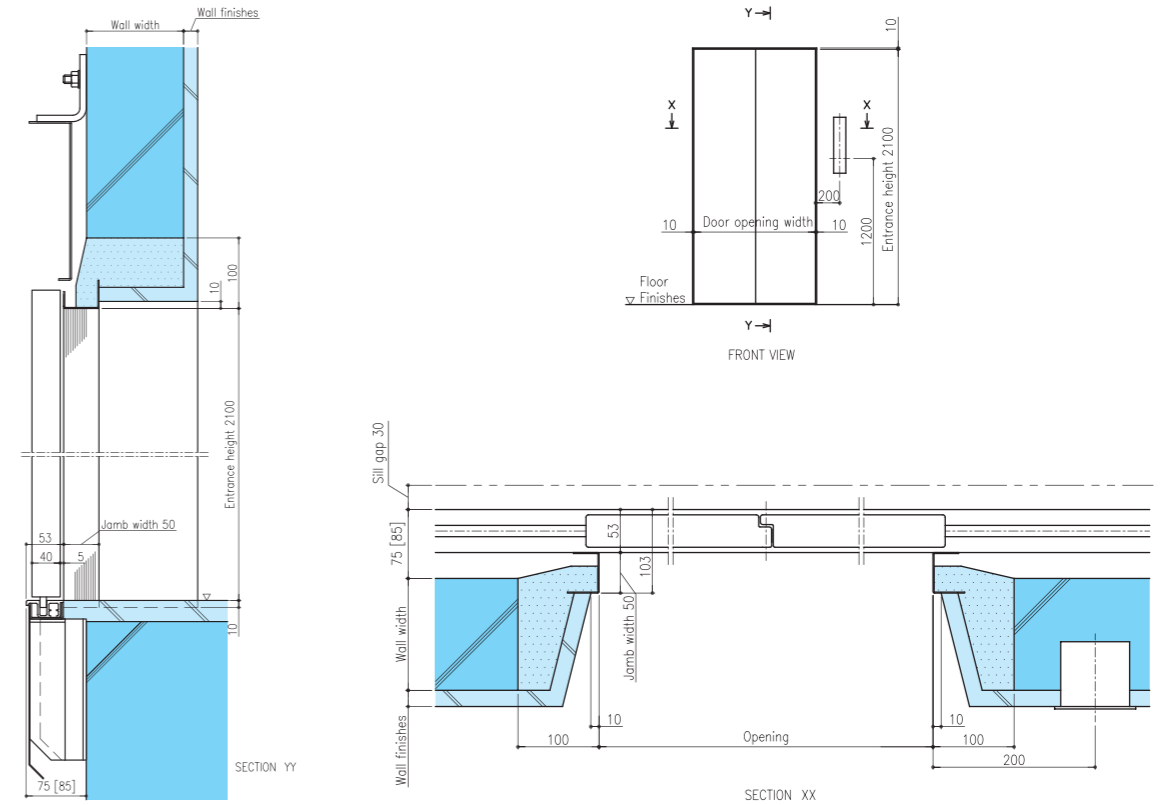



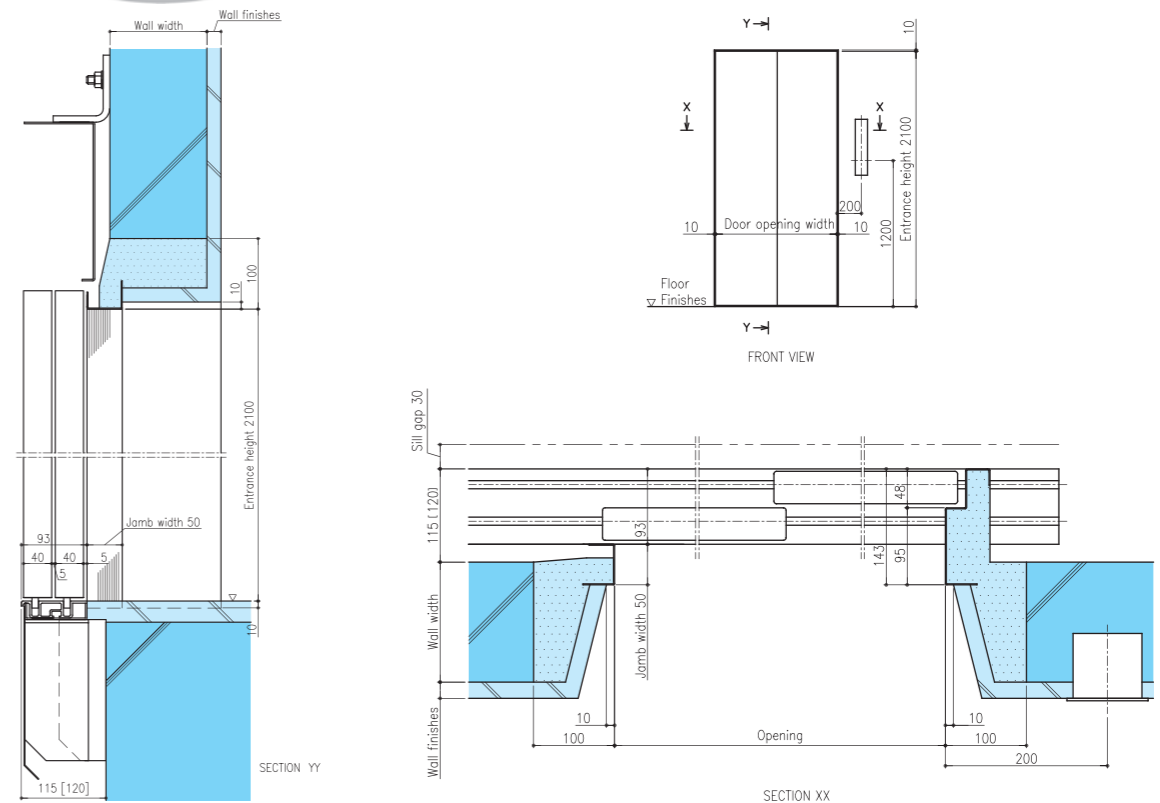



AS-1X (2S2P) Standard



Notes
 - [] : With fire rated door
 - This structure is not for fire insulation door. Please consult Hitachi or a local agent for detail.

Dimensions

-  Building structure (by other contractors)
-  Wall and floor finishing (by other contractors)
-  Grouting (by other contractors)

-  Building structure (by other contractors)
-  Wall and floor finishing (by other contractors)
-  Grouting (by other contractors)

SS-1X (2PCO) Option

(unit: mm)

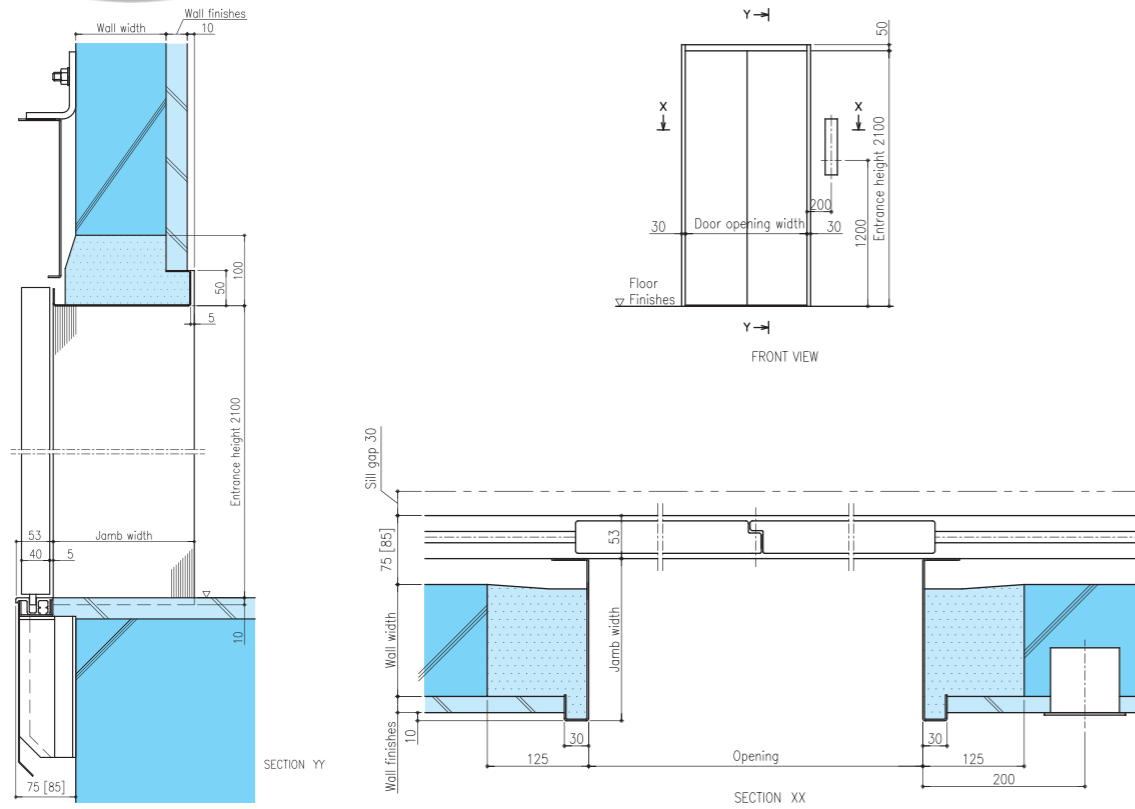

TS-1X (2PCO) Option

(unit: mm)

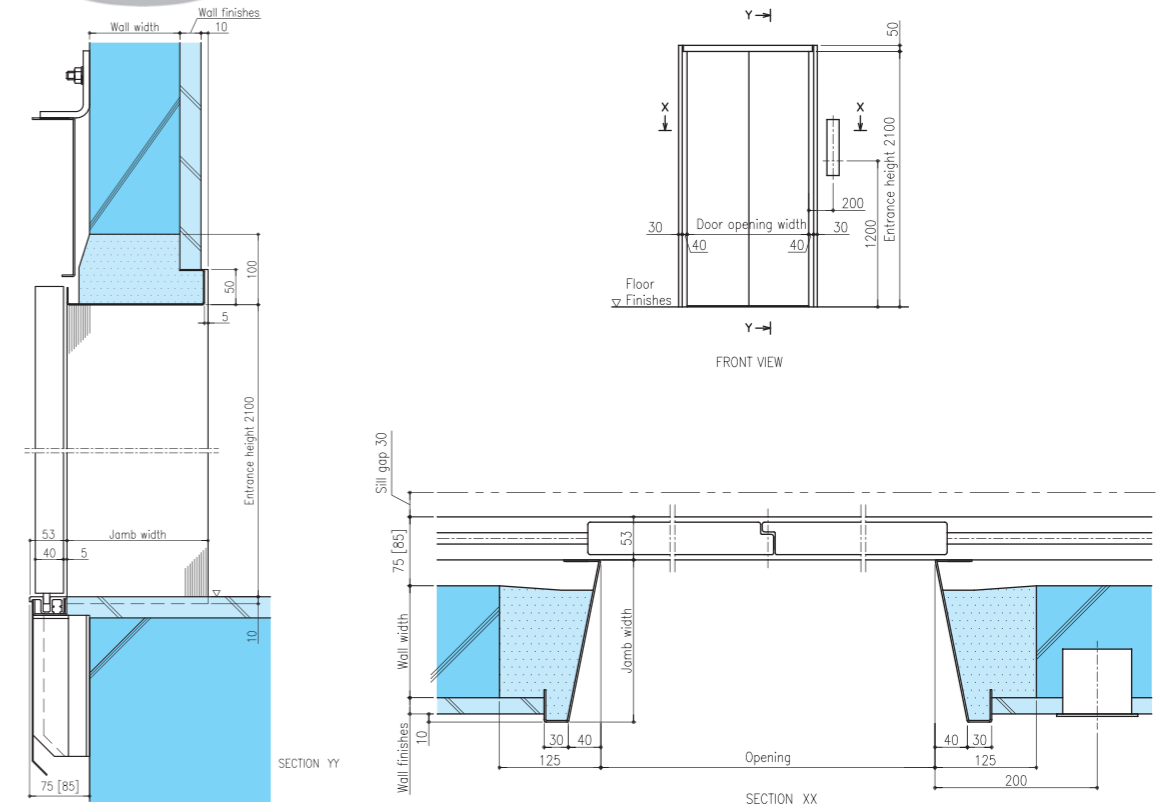

SS-1X (2S2P) Option

- Notes
- [] : With fire rated door
 - This structure is not for fire insulation door. Please consult Hitachi or a local agent for detail.

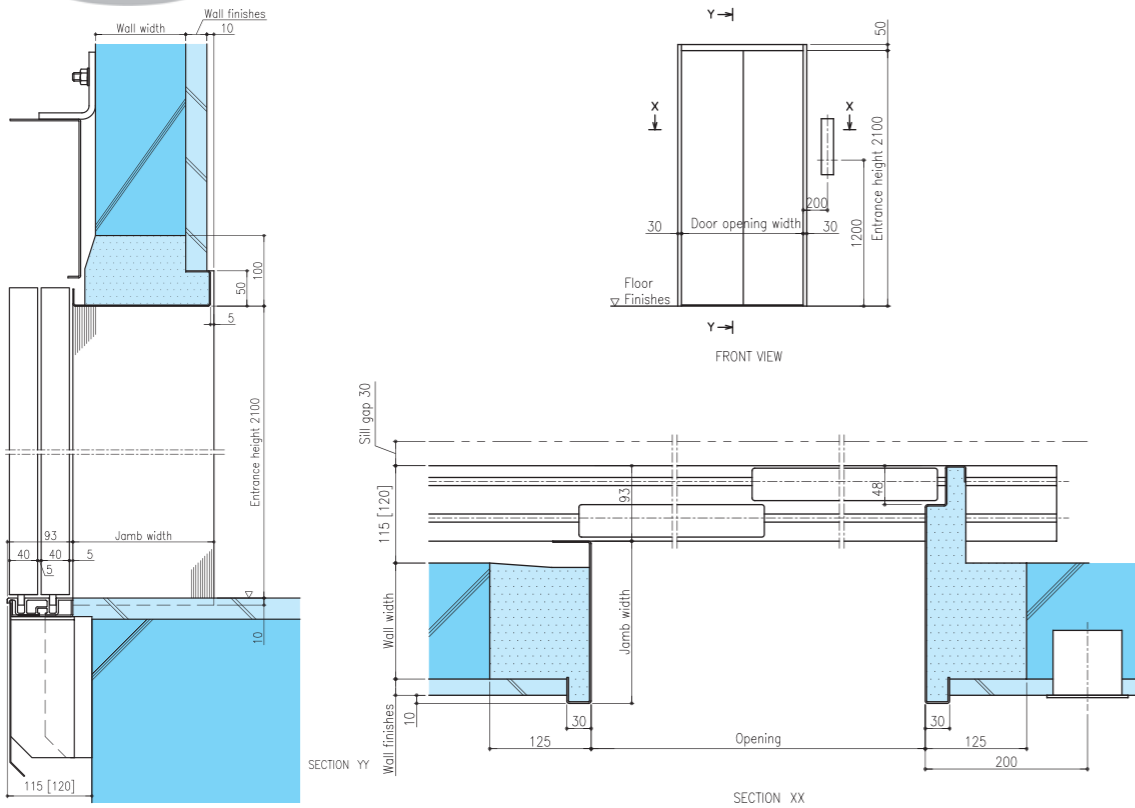





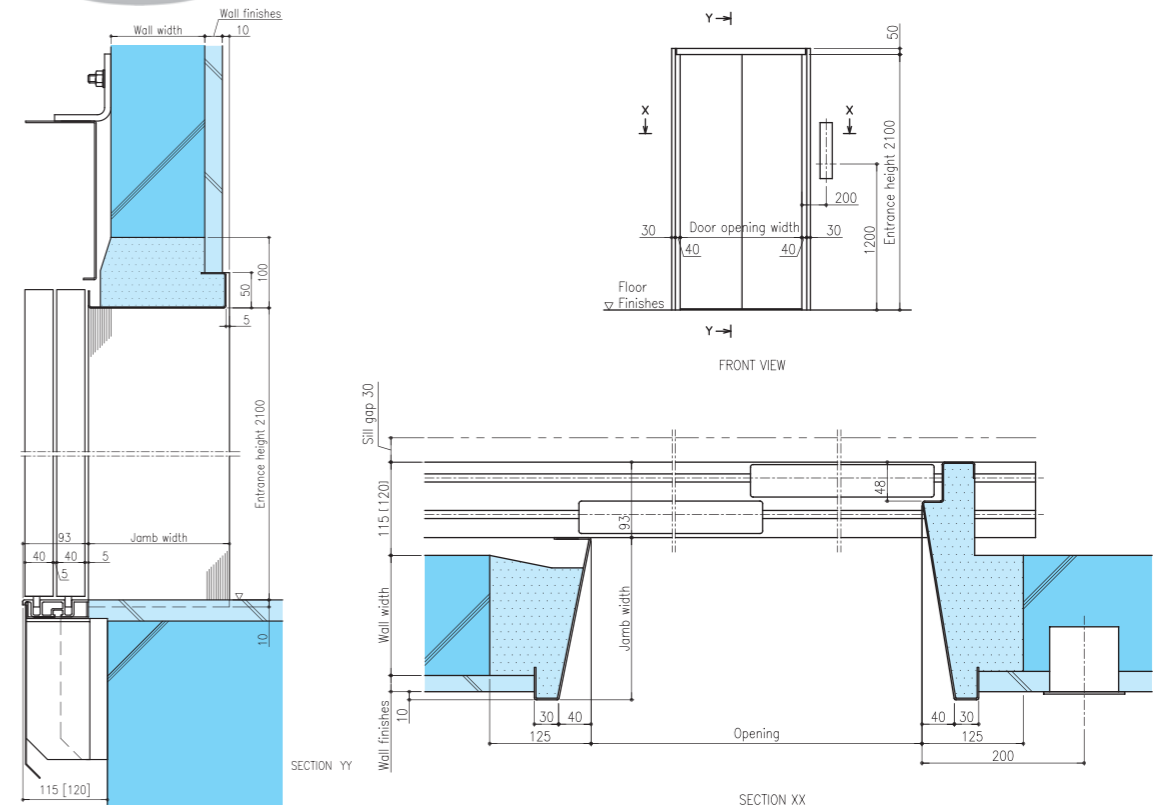

TS-1X (2S2P) Option

- Notes
- [] : With fire rated door
 - This structure is not for fire insulation door. Please consult Hitachi or a local agent for detail.



Dimensions

-  Building structure (by other contractors)
-  Wall and floor finishing (by other contractors)
-  Grouting (by other contractors)

-  Building structure (by other contractors)
-  Wall and floor finishing (by other contractors)
-  Grouting (by other contractors)

SL-2X (2PC0) Option

(unit: mm)

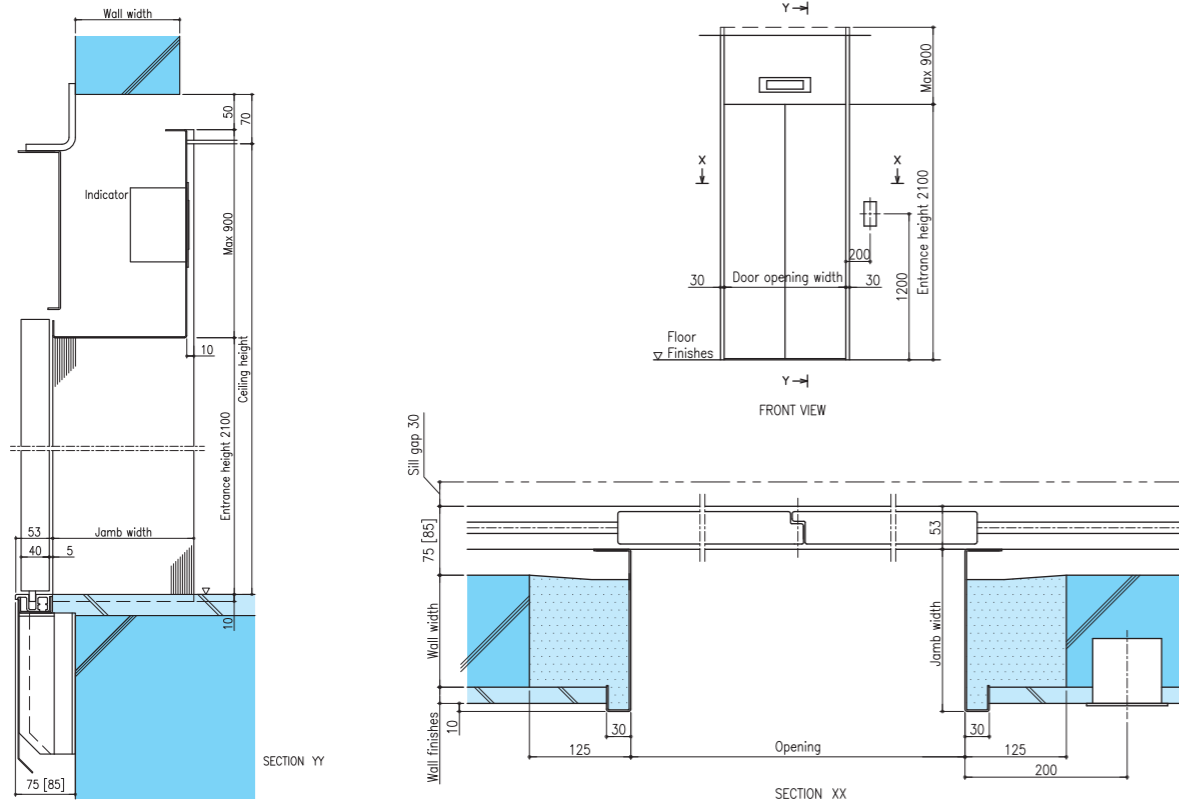

TL-2X (2PC0) Option

(unit: mm)

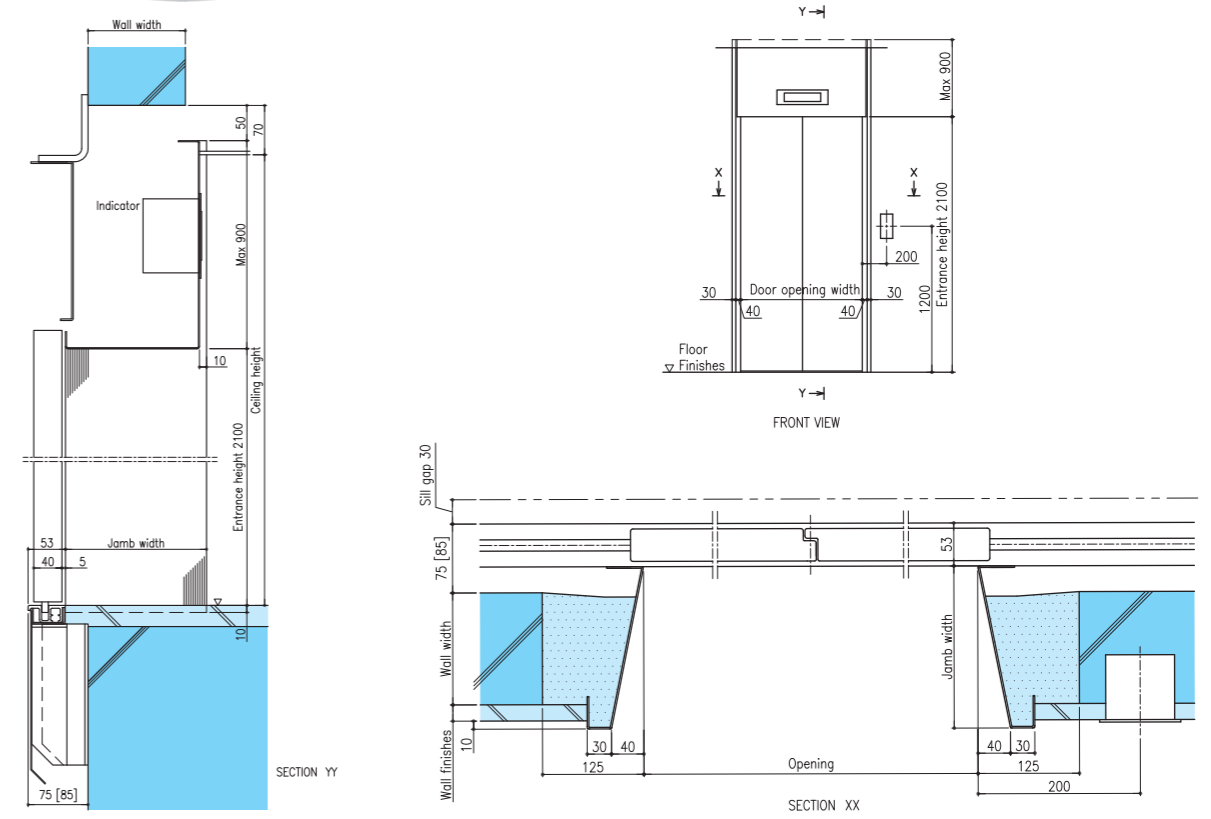

SL-2X (2S2P) Option

- Notes
- [] : With fire rated door
 - This structure is not for fire insulation door. Please consult Hitachi or a local agent for detail.

TL-2X (2S2P) Option

- Notes
- [] : With fire rated door
 - This structure is not for fire insulation door. Please consult Hitachi or a local agent for detail.

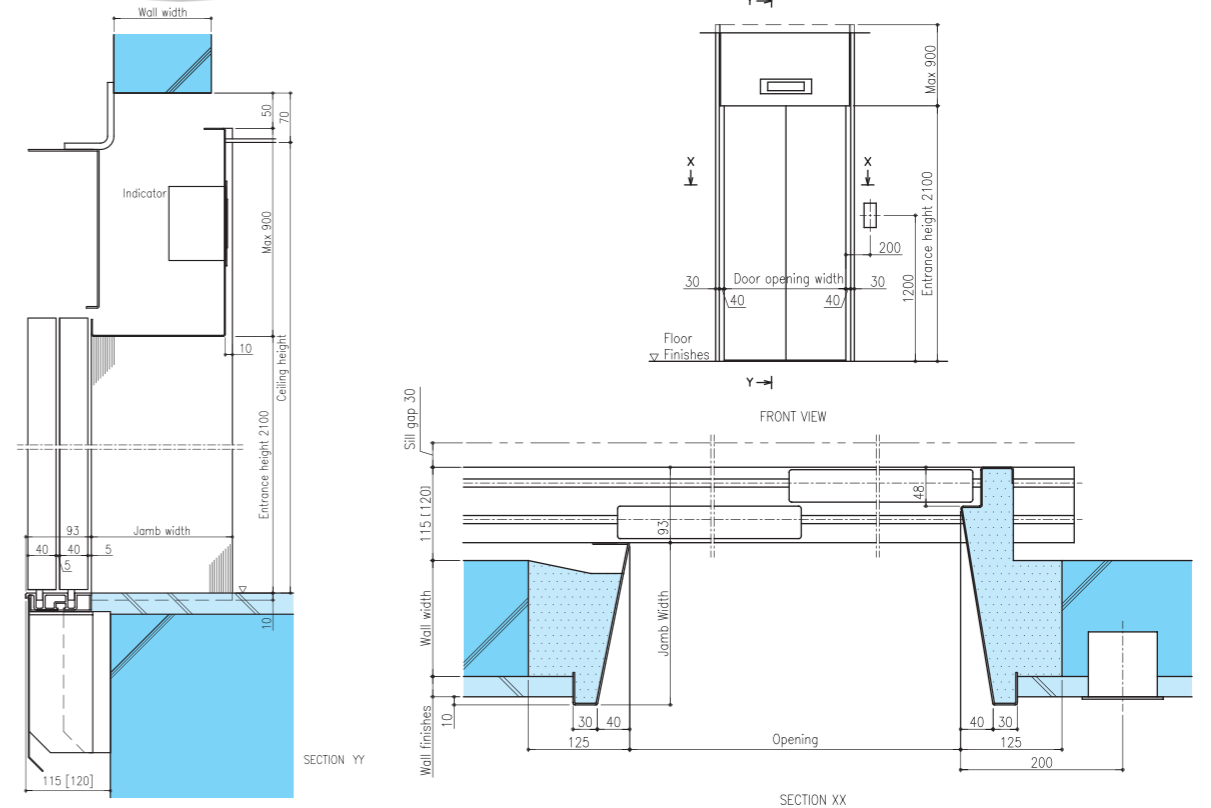
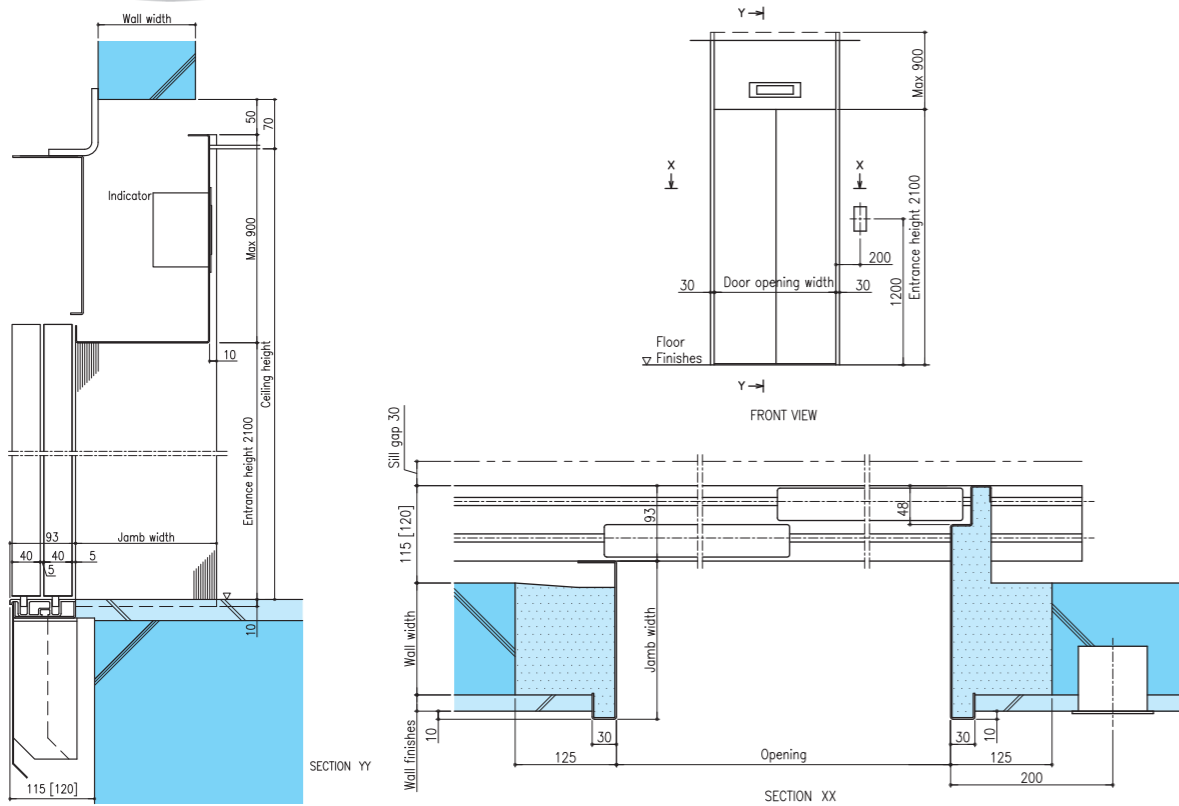

Work to be done by building contractors

The preparatory work for elevator installation outlined in the table below should be undertaken by building contractors in accordance with Hitachi drawings and in compliance with local or relevant codes and regulations.

No.	Items
1	Prepare hoistway with proper framing and enclosure, suitable pit of proper depth with drains and water-proofing if required, and properly lit and ventilated hoistway of adequate size with concrete floors, access doors, ladders and guards as required.
2	Provide and/or cut all necessary holes, chases, openings and finishes after equipment installation.
3	Supply and secure all supports, reinforced concrete slabs, etc., necessary for installation of the machinery, doors, buffers, etc.
4	Furnish all necessary cement and/or concrete for grouting of brackets, bolts, machine beams, etc.
5	Prepare and erect suitable scaffolding and protective measures during work in progress.
6	Furnish mains for three-phase electric power and single-phase lighting supply for car lighting and lift pit and power outlet to the hoistway, following the instructions of the elevator contractor on outlet position and wire size.
7	Provide, free of charge, a suitable theft-proof storage area for materials and tools during erection work.
8	Supply electric power for lighting of work area, installation work, elevator testing and spray painting.
9	Hoisting hook at top of the hoistway.
10	Hoistway ventilation to be provided to maintain the hoistway temperature at below 40°C.
11	Manufacture and installation of separating beam (if necessary).

Hitachi Eco-Achievement

Hitachi's elevators achieved the highest energy efficiency class rating.

ISO 25745 is an international standard for evaluating the energy consumption and classifying the energy efficiency of elevators and escalators. ISO 25745-2 applies to the energy efficiency of elevators. It establishes seven classes, from A to G, with class A representing the highest level of energy efficiency.

Hitachi's UAG-SN1 and OUG-ON1 have achieved the highest rating.

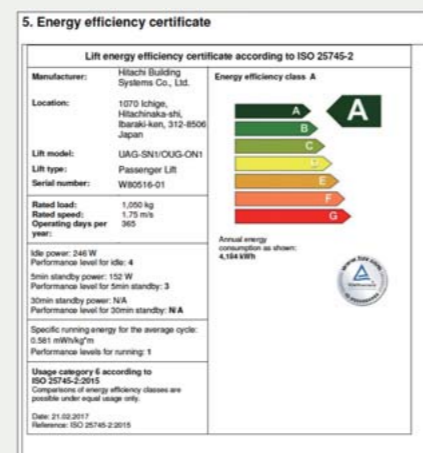

Energy efficiency class A

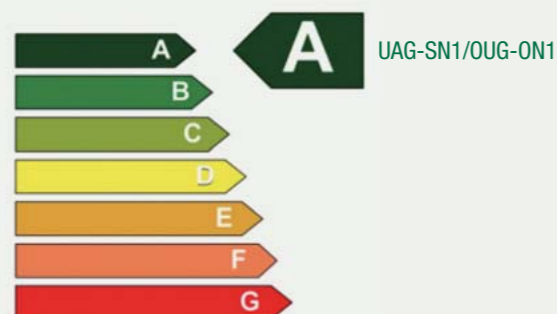

Model	UAG-SN1/OUG-ON1	UAG-SN1/OUG-ON1
Location	Japan	Japan
Rated load	1,050 kg	1,635 kg
Rated speed	1.75 m/s (105 m/min.)	1.75 m/s (105 m/min.)
No. of stops	4	4
Travel	19.5 m	19.5 m
Operating days per year	365	365
Annual energy consumption	4,184 kWh	4,633 kWh
Usage category	6	5
Classification of lift [A-G]	A	A

Notes
- The measured class differs depending on the usage conditions.

Environmental activities

The Hitachi Group is engaged in environmental initiatives at its factories and offices. Siam Hitachi Elevator Co., Ltd. (Thailand) is working to combat global warming by reducing energy consumption. Lighting in their production facilities areas has been switched to LED lighting, and they have reduced electricity consumption of lighting by approximately 70%.*

* Assuming the lighting fixtures (approximately 250 fixtures) are used under the same conditions.



Our achievement and future



The world's fastest elevator

Hitachi's elevator, which was delivered to Guangzhou CTF Finance Centre, a skyscraper complex building in Guangzhou, China, started operation with the speed of 1,260 m/min., the world's fastest* among all elevators operating today. The elevators feature technologies that support safe and comfortable operation, in addition to the drive and control technologies needed to attain the Ultrahigh-Speeds. Hitachi will utilize this achievement for future product development, and strive to offer elevators with higher running quality as well as safety and comfort.

* According to Hitachi's research as of January 2021

Drive and control technologies to attain Ultrahigh-Speed of 1,260 m/min.

Hitachi has developed a permanent magnet synchronous motor that achieves both a thin profile and the high output needed to attain a speed of 1,260 m/min.

Safety features supporting Ultrahigh-Speed elevator operation

Hitachi developed brake equipment using braking materials with outstanding heat resistance to safely stop the elevator car in the unlikely event that a malfunction is detected during Ultrahigh-Speed operation.



Traction mechanism for 1,260 m/min.

Elevators can be used comfortably with safety even over long travel.

Active guide rollers that detect minute warping in the guide rails and lateral vibration due to wind pressure are installed in the four corners (top and bottom, left and right) of the elevator car. This gives passengers a comfortable ride even during high-speed operation.

The sensation of ear blockage is reduced by Hitachi's proprietary air pressure adjustment technology, which reduces the changes in air pressure inside the elevator car that would otherwise be caused by vertical movement through long travel.

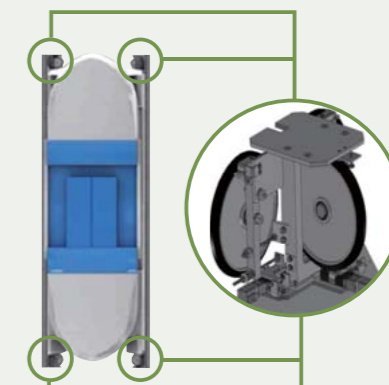

Active guide rollers (3D model)



Research and development

Modern manufacturing plants in Thailand and Singapore supply valuable products to customers. Equipment is made to the highest standards of quality and reliability on cutting-edge production lines.



Siam Hitachi Elevator Co., Ltd. (Thailand)



Hitachi Elevator Asia Pte. Ltd. (Singapore)

Excellence and flexibility in design at manufacturing plants in Thailand and Singapore

The modern manufacturing plant in Thailand and Singapore boasts a complete team of local and Japanese engineers and is geared towards providing maximum flexibility in design and manufacturing to suit customer requirements.

High accuracy and efficiency in planning of equipment layout is made possible by the most advanced CAD systems.

Equipment is made to the highest standards of quality and reliability with modern CNC machinery.



Mito Works, Hitachi, Ltd. (Japan)

An integrated engineering system from development to design and production

Head office, research centers, and plants work closely together to develop new technologies.

Staff throughout the company work together as one team to conduct research and develop technologies.

High performance simulator enhances overall elevator system efficiency.

A high-performance simulator is utilized for all stages of elevator development, from planning through system design. Planning, research and development are carried out according to the results of this statistical analysis.

Cutting-edge CAD/CAM systems

The latest in CAD/CAM systems help us carry out elevator layout and various other design and production steps more quickly and efficiently.

Wiring Diagram

— shows the works to be done by building.

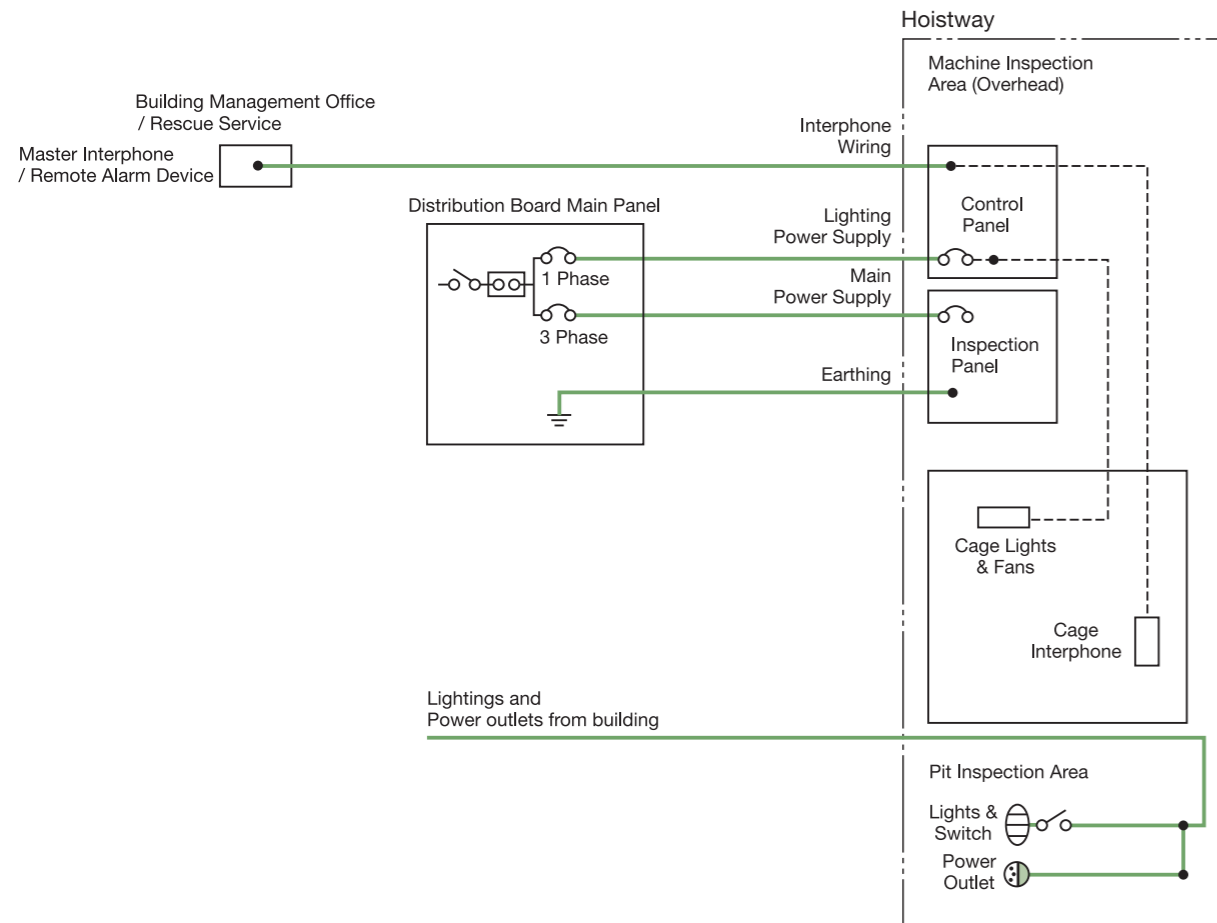

Work to be provided by building

Item	Works to be provided by building
Main power supply *1	To provide AC 3 phase 200 to 480V 50/60Hz main power supply with maintaining to ensure that the power supply does not fluctuate outside the range of -10% to +10% of the normal voltage rating and to ensure that the unbalance factor of voltage does not exceed 5%.
Lighting power supply *1	To supply and install AC single phase (20Amp) lighting power supply for car lighting, EBOPS and maintenance work.
Interphone *1	To provide piping and wiring (12 wires of 0.9mm ² /elevator) for interphone located outside the hoistway.
Pit, hoistway lightings & power outlets	To supply and install AC single phase power outlet and lighting with switch located at accessible area from the entrance at bottom landing level for maintenance purpose. Arrange necessary to comply to local code & regulation.

Notes
 - In the case that builder provides leak current detector at the side of main power, please use "inverter type" or "detector which does not do unnecessary operation for high frequency".
 *1 Main power, lighting power, indicator power supply and interphone wiring shall be led into the hoistway at the highest lift landing.

MACHINE ROOM-LESS ELEVATOR

Model OUG Series ON1 PLANNING INFORMATION

Hoistway dimension

2PCO

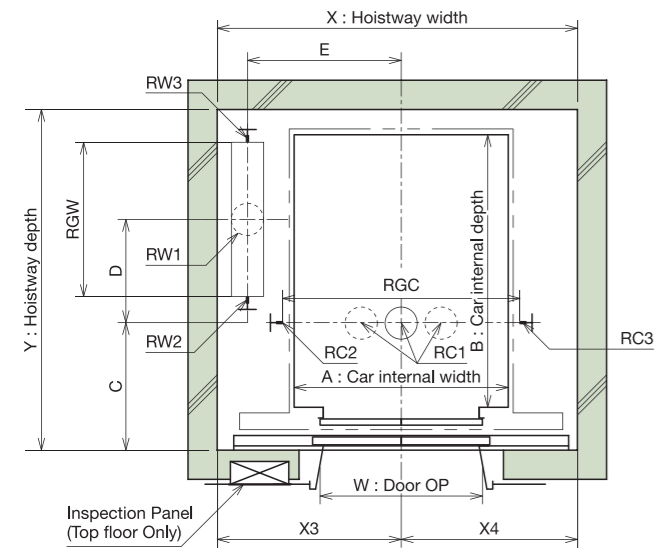

Hoistway dimension and Pit reaction loading

2S2P

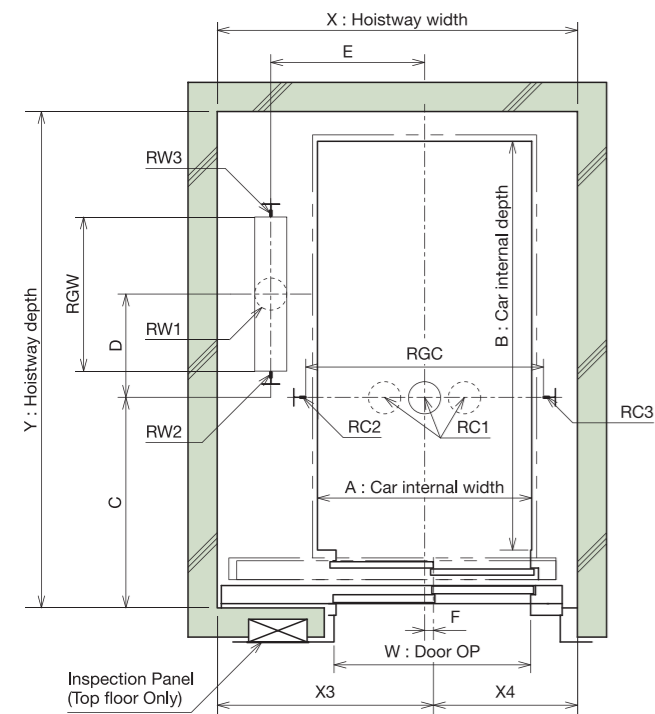

Hoistway dimension and Pit reaction loading

Based on Hitachi standard, EN81-20/50 and SASO-EN81-20/50

No.	Load [kg]	Persons	Rated speed [m/s] (m/min)	Door type	Door OP width W [mm]	Car internal size A x B [mm]	Hoistway X x Y [mm]	Location [mm]							Pit reaction loading *3,4,5 [kN]																																																			
								X3	X4 *1	C *2	D	E	F	RGC	RGW	Car side			Counterweight side																																															
																RC1	RC2	RC3	RW1	RW2	RW3																																													
1	630	8	1.0(60)	2PCO	800	1100x1400	1900x1800	1000	900	680 [690]	845	1330	72.5	35.0(221.5)	28.5(215.0)	28.5(215.0)	59.5	16.0(198.5)	25.5(212.0)																																															
2			1.5(90)			1400x1100	2050x1700 (2100x1700)	1105	945 (995)	635 [645]	530	950								1540	800	35.0(221.5)	28.5(215.0)	31.5(274.0)	28.5(215.0)	16.0(198.5)	25.5(212.0)																																							
3			1.75(105)																									2150x1800	1150	1000	680 [690]	970	1580	79.5	37.5(227.0)	30.5(219.5)	64.0	16.5(201.5)	27.0(216.0)																											
4			1.0(60)																																					1350x1400	1235	1015	705 [715]	640	1030	90.0	64.5(689.5)	54.5(679.0)	81.5	19.0(259.5)	30.0(274.5)															
5			1.5(90)																																																	1500x1450	1175	1025	705 [715]	530	1000	1640	91.0	41.0(230.5)	33.0(222.5)	73.0	17.0(201.5)	29.0(218.0)		
6			1.75(105)																																																														2350x2000	1285
7	1.0(60)	1600x1350	1315	1085	655 [665]								530	1105	1740	92.0	41.5(228.0)	33.5(220.0)	74.0																																															
8	1.5(90)					2350x1750 (2400x1750)	1315	1085	655 [665]	530	1105	800								109.0	69.0(693.5)	58.0(682.5)	90.5	36.0(651.0)	54.5(679.0)																																									
9	1.75(105)																									2450x2000	1335	1115	705 [715]	640	1110	800	111.0	69.0(693.5)	58.0(682.5)	92.5	36.0(651.0)	55.0(679.5)																												
10	2.0(120)																																						1900x2400	1010	890	980 [990]	530	845	1330	94.0	42.0(230.5)	33.5(222.5)	74.5	17.0(201.5)	29.0(218.0)															
11	2.5(150)																																																			2050x2400	1130	920	980 [990]	640	905	900	114.0	69.0(693.5)	58.5(683.0)	94.0	36.0(652.0)	55.0(679.5)		
12	1.0(60)																																																																1100x2000	1110
13	1.5(90)	1900x2450	1110	790	1057 [1062]								530	845	800	94.0	45.5(289.5)	37.0(282.0)	74.5																																															
14	1.75(105)					2000x2450	1205	795	1062	640	905	900								114.0	70.0(694.5)	58.5(683.0)	94.0	36.5(651.0)	55.5(680.0)																																									
15	2.0(120)																									1600x1400	1225	1075	680 [690]	530	1050	1740	98.0	43.0(232.0)	34.5(223.5)	77.0	17.5(201.5)	29.5(219.0)																												
16	2.5(150)																																						2450x2000	1335	1115	705 [715]	640	1110	900	117.0	70.0(695.0)	59.5(684.0)	95.5	36.5(652.0)	55.5(680.0)															
17	1.0(60)																																																			1000x2400	1015	785	1257 [1262]	530	795	1230	100.5	44.0(233.0)	35.5(224.5)	79.5	17.5(201.5)	30.5(219.5)		
18	1.5(90)																																																																1900x2850	1105
19	1.75(105)	2000x2500	1005	995	1030 [1040]								530	845	800	99.0	43.5(230.0)	35.0(221.5)	77.5																																															
20	2.0(120)					2150x2500	1130	1020	1040	640	905	900								117.0	70.0(695.0)	59.5(684.0)	95.5	36.5(652.0)	55.5(680.0)																																									
21	2.5(150)																									1100x2100	1115	835	1107 [1112]	530	845	1330	96.5	43.0(229.5)	34.5(221.0)	77.0	17.5(198.5)	29.5(216.0)																												
22	1.0(60)																																						1900x2550 (1950x2550)	1115	785 (835)	1107 [1112]	530	845	800	97.5	46.5(289.0)	38.0(280.5)	78.0	20.0(256.5)	33.0(275.0)															
23	1.5(90)																																																			2000x2550	1155	845	1112	640	905	900	117.0	70.5(695.5)	59.5(684.0)	95.5	36.5(651.0)	56.0(680.5)		
24	1.75(105)																																																																2300x1900	1225
25	2.0(120)	2450x2000	1335	1115	740								640	1110	900	117.0	70.0(695.0)	59.5(684.0)	95.5																																															
26	2.5(150)					1600x1500	1335	1115	740	640	1110	800								117.0	70.0(695.0)	59.5(684.0)	95.5	36.5(652.0)	55.5(680.0)																																									

Notes
 - Above tables shows the dimensions on the following conditions
 (1) Single elevator in hoistway (2) Without counterweight safety
 Please consult Hitachi or local agent if other specifications are required.
 *1 (): Travel distance > 60m
 *2 (): With fire rated door
 *3 (): EN81-20/50
 *4 Rated speed 1.0m/s : Travel distance ≤ 60m
 Rated speed 1.5 , 1.75m/s : Travel distance ≤ 80m
 Rated speed 2.0 , 2.5m/s : Travel distance ≤ 120m
 *5 The pit reaction loading differs depending on the specifications and design, please consult Hitachi or local agent.

Based on Hitachi standard, EN81-20/50 and SASO-EN81-20/50

No.	Load [kg]	Persons	Rated speed [m/s] (m/min)	Door type	Door OP width W [mm]	Car internal size A x B [mm]	Hoistway X x Y [mm]	Location [mm]								Pit reaction loading ^{*3+4+5} [kN]											
								X3	X4 ^{*1}	C ^{*2}	D	E	F	RGC	RGW	Car side			Counterweight side								
																RC1	RC2	RC3	RW1	RW2	RW3						
57			1.0(60)																								
58			1.5(90)																								
59			1.75(105)			1600x1700	2400x2100	1295	1105		830 [840]		1110			1740				122.5	57.0(389.0)	46.0(377.5)		98.0	24.5(347.0)	40.5(372.5)	
60			2.0(120)																								
61			2.5(150)																								
62			1.0(60)		1000																						
63			1.5(90)																								
64	1200		1.75(105)	2PCO		1800x1500	2600x2000	1390	1210		730 [740]		1210			1940				121.5	61.5(491.0)	50.0(479.5)		98.5	28.5(448.0)	44.5(474.0)	
65			2.0(120)																								
66			2.5(150)																								
67		16	1.0(60)																								
68			1.5(90)																								
69			1.75(105)			2000x1400	2800x1950	1495	1305		680 [690]		1310			2140				122.5	57.0(389.0)	46.0(377.5)		98.0	24.5(347.0)	40.5(372.5)	
70			2.0(120)																								
71			2.5(150)																								
72			1.0(60)		1100																						
73			1.5(90)																								
74	1250		1.75(105)	2S2P		1200x2300	2100x2750	1210	890		1207 [1212]		955	45	1430					124.5	58.0(389.5)	46.5(378.0)		99.0	24.5(346.5)	41.0(372.5)	
75			2.0(120)																								
76			2.5(150)																								
77			1.0(60)																								
78			1.5(90)		1000	1800x1700	2600x2100	1395	1205		830 [840]	640	1210			1940	900										
79			1.75(105)																								
80			2.0(120)																								
81			2.5(150)																								
82			1.0(60)																								
83			1.5(90)																								
84	1350	18	1.75(105)	2PCO		2000x1500	2800x2000	1495	1305		730 [740]																
85			2.0(120)																								
86			2.5(150)																								
87			1.0(60)		1100																						
88			1.5(90)																								
89			1.75(105)			2000x1550	2800x2050	1495	1305		755 [765]																
90			2.0(120)																								
91			2.5(150)																								
92			1.0(60)																								
93			1.5(90)																								
94			1.75(105)		1000	1300x2300	2250x2700	1170	1080		1130 [1140]																
95			2.0(120)																								
96			2.5(150)																								
97			1.0(60)																								
98			1.5(90)																								
99	1425	19	1.75(105)	2S2P	1100	1300x2300	2200x2750	1290	910		1207 [1212]		95														
100			2.0(120)																								
101			2.5(150)																								
102			1.0(60)																								
103			1.5(90)																								
104			1.75(105)		1000	1800x1750	2600x2150	1395	1205		855 [865]		1210			1940											
105			2.0(120)																								
106			2.5(150)	2PCO																							
107			1.0(60)																								
108			1.5(90)																								
109	1600	21	1.75(105)		1100	1400x2400	2500x2800	1245	1255		1180 [1190]		1055			1630											
110			2.0(120)																								
111			2.5(150)																								

Notes

- Above tables shows the dimensions on the following conditions
 (1) Single elevator in hoistway (2) Without counterweight safety
 Please consult Hitachi or local agent if other specifications are required.

*1 (): Travel distance > 60m
 *2 []: With fire rated door
 *3 (): EN81-20/50
 *4 Rated speed 1.0m/s : Travel distance ≤ 60m
 Rated speed 1.5 , 1.75m/s : Travel distance ≤ 80m
 Rated speed 2.0 , 2.5m/s : Travel distance ≤ 120m
 *5 The pit reaction loading differs depending on the specifications and design, please consult Hitachi or local agent.

Dimension of Hoistway and Pit Reaction Loading

Dimension and reaction loading of hoistway

Based on Malaysian regulations

No.	Load [kg]	Persons	Rated speed [m/s] (m/min)	Door type	Door OP width W [mm]	Car internal size A x B [mm]	Hoistway X x Y [mm]	Location [mm]										Pit reaction loading *2*3 [kN]																																																													
														Car side				Counterweight side																																																													
								X3	X4 *1	C	D	E	F	RGC	RGW	RC1	RC2	RC3	RW1	RW2	RW3																																																										
54	1365	20	1.0(60)	2PCO	1000	1800x1750	2600x2150	1395	1205	865	1210	1940							66.5x2sets	392.5	380.5		346.5	374.0																																																							
55			1.5(90)										133.0	497.0	484.5	105.5	450.0	478.0																																																													
56			1.75(105)										141.0	709.5	696.0	113.5	656.5	691.5																																																													
57			2.0(120)																66.5x2sets	387.0	375.0		341.5	369.0																																																							
58			2.5(150)																133.0	489.5	479.0	105.5	445.0	473.5																																																							
59			1.0(60)										1100	2000x1550	2800x2050	1495	1305	765	1310	2140										141.0	709.5	696.0	113.5	656.5	691.5																																												
60			1.5(90)																											71.5x2sets	390.5	377.5		341.5	371.0																																												
61			1.75(105)																											145.0	496.0	483.0	115.5	444.5	475.5																																												
62			2.0(120)																											75.0x2sets	398.0	384.5		347.0	377.5																																												
63			2.5(150)																											150.0	502.5	489.0	118.5	450.0	481.0																																												
64			1.0(60)																					1500	22	2S2P	1200	1400x2400	2300x2850	1355	945	1262	1055	95	1630							60.5x2sets	398.0	384.5		347.0	377.5																																
65			1.5(90)																																							160.5	715.5	701.0	129.0	656.5	695.0																																
66			1.75(105)																																							155.5	504.0	490.0	122.5	450.0	482.0																																
67			2.0(120)																																							83.0x2sets	396.5	388.5		353.0	382.0																																
68			2.5(150)																																							166.0	500.5	493.0	132.0	456.0	486.0																																
69			1.0(60)																																	1565	23	2PCO	1100	2000x1750	2800x2150	1495	1305	865	640									86.5x2sets	398.0	390.5		353.0	383.5																				
70			1.5(90)																																																			173.0	502.5	494.5	136.5	456.5	487.5																				
71			1.75(105)																																																			88.0x2sets	399.0	391.0		353.0	384.0																				
72			2.0(120)																																																			176.0	503.5	495.5	137.5	456.5	488.0																				
73			2.5(150)																																																			90.25x2sets	400.5	392.0		353.5	384.5																				
74	1.0(60)	1635	24	2PCO	1100	2000x1800	2800x2200	1495	1305	890																																													180.5	504.5	496.5	141.0	456.5	488.5																			
75	1.5(90)																																																																														
76	1.75(105)																																																																														
77	2.0(120)																																																																														
78	2.5(150)																																																																														
79	1.0(60)												1705	25	2S2P	1200	1500x2500	2500x2950	1555	945	1312	1130	145																										1730							88.0x2sets	399.0	391.0		353.0	384.0																		
80	1.5(90)																																																																														
81	1.75(105)																																																																														
82	2.0(120)																																																																														
83	2.5(150)																																																																														
84	1.0(60)																							1835	27	2PCO	1100	2000x2000	2900x2400	1610	1290	990	1335		2140																					90.25x2sets	400.5	392.0		353.5	384.5																		
85	1.5(90)																																																																														
86	1.75(105)																																																																														
87	2.0(120)																																																																														
88	2.5(150)																																																																														
89	1.0(60)																																			1905	28	2S2P	1300	1500x2700	2500x3150	1505	995	1412	1130	95	1730									180.5	504.5	496.5	141.0	456.5	488.5																		
90	1.5(90)																																																																														
	1.75(105)																																																																														

Notes
 - Above tables shows the dimensions on the following conditions
 (1) Single elevator in hoistway (2) Without counterweight safety
 (3) With fire rated door
 Please consult Hitachi or local agent if other specifications are required.

*1 (): Travel distance > 60m
 *2 Rated speed 1.0m/s : Travel distance ≤ 60m
 Rated speed 1.5, 1.75m/s : Travel distance ≤ 80m
 Rated speed 2.0, 2.5m/s : Travel distance ≤ 120m
 *3 The pit reaction loading differs depending on the specifications and design, please consult Hitachi or local agent.

Based on Hitachi standard for India

No.	Load [kg]	Persons	Rated speed [m/s] (m/min)	Door type	Door OP width W [mm]	Car internal size A x B [mm]	Hoistway X x Y [mm]	Location [mm]										Pit reaction loading *3*4 [kN]																																														
														Car side				Counterweight side																																														
								X3	X4 *1	C *2	D	E	F	RGC	RGW	RC1	RC2	RC3	RW1	RW2	RW3																																											
1	612	9	1.0(60)	2PCO	800	1100x1400	1900x1800	1000	900	680 [690]	845	1330	800							71.5	34.0	28.0	59.5	16.0	25.0																																							
2			1.5(90)											133.0	497.0	484.5	105.5	450.0	478.0																																													
3			1.75(105)											141.0	709.5	696.0	113.5	656.5	691.5																																													
4			2.0(120)																	66.5x2sets	387.0	375.0		341.5	369.0																																							
5			2.5(150)																	133.0	489.5	479.0	105.5	445.0	473.5																																							
6			1.0(60)											1400x1100	(2100x1700)	1105	(995)	635 [645]	530	950	1540	800	71.0	1540							34.0	27.5	27.5	59.0	18.5	27.5																												
7			1.5(90)																												75.0x2sets	398.0	384.5		347.0	377.5																												
8			1.75(105)																												150.0	502.5	489.0	118.5	450.0	481.0																												
9			2.0(120)																												160.5	715.5	701.0	129.0	656.5	695.0																												
10			2.5(150)																												155.5	504.0	490.0	122.5	450.0	482.0																												
11			1.0(60)																						1350x1400		1235	1015	705 [715]	640	1030	1580	900	97.0	900							64.0	41.0	33.5	64.0	19.0	29.5																	
12			1.5(90)																																							77.5x2sets	399.5	386.0		347.0	378.0																	
13			1.75(105)																																							145.0	496.0	483.0	115.5	444.5	475.5																	
14			2.0(120)																																							75.0x2sets	398.0	384.5		347.0	377.5																	
15			2.5(150)																																							150.0	502.5	489.0	118.5	450.0	481.0																	
16			1.0(60)																																	1100x2000		1130	920	980 [990]	640	905	1330	900	110.5	900							41.0	33.0	33.0	72.5	17.0	28.5						
17			1.5(90)																																																		160.5	715.5	701.0	129.0	656.5	695.0						
18			1.75(105)																																																		155.5	504.0	490.0	122.5	450.0	482.0						
19			2.0(120)																																																		83.0x2sets	396.5	388.5		353.0	382.0						
20			2.5(150)																																																		166.0	500.5	493.0	132.0	456.0	486.0						
21	1.0(60)	1500x1450		1205	795	705 [715]	640	905	1640	800	90.5	800																																			72.5	44.5	36.0	72.5	19.5	31.5												
22	1.5(90)																																														86.5x2sets	398.0	390.5		353.0	383.5												
23	1.75(105)																																														145.0	496.0	483.0	115.5	444.5	475.5												
24	2.0(120)																																														75.0x2sets	398.0	384.5		347.0	377.5												
25	2.5(150)																																														150.0	502.5	489.0	118.5	450.0	481.0												
26	1.0(60)												1600x1350		1335	1115	705 [715]	640	1110	1740	900	110.5	900																								41.0	33.0	33.0	72.5	17.0	28.5												
27	1.5(90)																																														77.5x2sets	399.5	386.0		347.0	378.0												
28	1.75(105)																																														145.0	496.0	483.0	115.5	444.5	475.5												
29	2.0(120)																																														75.0x2sets	398.0	384.5		347.0	377.5												
30	2.5(150)																																														150.0	502.5	489.0	118.5	450.0	481.0												
31	1.0(60)																							1500x1450		1285	1065	705 [715]	640	1060	1640	900	108.5	900													41.0	33.0	33.0	72.5	19.5	31.5												
32	1.5(90)																																														86.5x2sets	398.0	390.5		353.0	383.5												
33	1.75(105)																																														145.0	496.0	483.0	115.5	444.5	475.5												
34	2.0(120)																																														75.0x2sets	398.0	384.5		347.0	377.5												
35	2.5(150)																																														150.0	502.5	489.0	118.5	450.0	481.0												
36	1.0(60)																																		1600x1350		1335	1115	705 [715]	640	1110	1740	900	110.5	900							41.0	33.0	33.0	72.5	19.5	31.5							
37	1.5(90)																																																			86.5x2sets	398.0	390.5		353.0	383.5							
38	1.75(105)																																																			145.0	496.0	483.0	115.5	444.5	475.5							
39	2.0(120)																																																			75.0x2sets	398.0	384.5		347.0	377.5							
40	2.5(150)																																																			150.0	502.5	489.0	118.5	450.0	481.0							
41	1.0(60)	1100x2100		1335	1115	705 [715]	640	1110	1740	900	110.5	900																																								41.0	33.0	33.0	72.5	19.5	31.5							
42	1.5(90)																																																			77.5x2sets	399.5	386.0		347.0	378.0							
43	1.75(105)																																																			145.0	496.0	483.0	115.5	444.5	475.5							
44	2.0(120)																																																			75.0x2sets	398.0	384.5		347.0	377.5							
45	2.5(150)																																																			150.0	502.5	489.0	118.5	450.0	481.0							
46	1.0(60)												1500x1450		1285	1065	705 [715]	640	1060	1640	900	108.5	900																													41.0	33.0	33.0	72.5	19.5	31.5							
47	1.5(90)																																																			86.5x2sets	398.0	390.5		353.0	383.5							
48	1.75(105)																																																			145.0	496.0	483.0	115.5	444.5	475.5							
49	2.0(120)																																																			75.0x2sets	398.0	384.5		347.0	377.5							
50	2.5(150)																																																			150.0	502.5	489.0	118.5	450.0	481.0							
51	1.0(60)																							1600x1350		1335	1115	705 [715]	640	1110	1740	900	110.5	900																		41.0	33.0	33.0	72.5	19.5	31.5							
52	1.5(90)																																																			86.5x2sets	398.0	390.5		353.0	383.5							
53	1.75(105)																																																			145.0	496.0	483.0	115.5	444.5	475.5							
54	2.0(120)																																																			75.0x2sets	398.0	384.5		347.0	377.5							
55	2.5(150)																																																			150.0	502.5	489.0	118.5	450.0	481.0							
56	1.0(60)																																																															

Dimension of Hoistway and Pit Reaction Loading

Dimension and reaction loading of hoistway

Based on SS550

No.	Load [kg]	Persons	Rated speed [m/s] (m/min)	Door type	Door OP width W [mm]	Car internal size A × B [mm]	Hoistway X × Y [mm]	Location [mm]									Pit reaction loading *3*4 [kN]																										
								X3			X4			C	D	E	F	RGC	RGW	Car side			Counterweight side																				
								X3	X4	C	RC1	RC2	RC3							RW1	RW2	RW3																					
1	600	8	1.0(60)	2PCO	800	1100×1400	1950×1850	1035	915	680 [690]	845	1330	71.5	35.0	28.0	59.0	16.0	25.5																									
2			1.5(90)											38.5	31.5		18.5	28.5																									
3			1.75(105)											1400×1100	2150×1750		1150	1000	635 [645]	530	950	1540	800	71.5	35.0	28.0	16.0	25.5															
4			1.0(60)																						38.5	31.5	18.5	28.5															
5			1.5(90)																						37.0	30.0	16.5	26.5															
6			1.75(105)																						40.5	33.0	19.0	29.5															
7	750	11	1.0(60)	2PCO	900	1350×1400	2200×1850	1175	1025	680 [690]	970	1580	78.0	37.0	30.0	63.0	16.5	26.5																									
8			1.5(90)											41.0	33.0		17.0	28.5																									
9			1.75(105)											2300×2050	1260		1040	640	1030	900	101.0	66.0	55.5	85.5	35.5	53.0	72.5	41.0	33.0	17.0	28.5												
10			2.0(120)																									44.5	36.0	19.5	31.5												
11			2.5(150)																									1500×1450	1200	1050	705 [715]	530	1000	1640	800	90.5	41.0	33.0	72.5	44.5	36.0	19.5	31.5
12			1.0(60)											41.0	33.0		17.0	28.5																									
13			1.5(90)											2400×2050	1310		1090	640	1060	900	108.5	68.0	57.0	90.0	36.0	54.5	91.5													38.0	33.5	21.0	28.5
14			1.75(105)																																					41.0	36.5	24.0	31.5
15			2.0(120)											2450×1800	1355		1095	655 [665]	530	1105	1740	800	91.5	41.0	36.5	73.5	41.0													36.5	24.0	31.5	
16			2.5(150)																								41.0	36.5	24.0	31.5													
17	1.0(60)	2500×2050	1360	1140	705 [715]	640	1110	900	108.5	68.0	57.0	90.0	36.0			54.5											91.5	41.0	33.0	17.0	29.0												
18	1.5(90)													41.0	33.0		17.0	29.0																									
19	1.75(105)													1950×2500	1135		815	1057 [1062]	530	845	1330	800	91.0	44.5	36.5	73.0		44.5	36.5	73.0	20.0	32.0											
20	2.0(120)																											44.5	36.5	73.0	20.0	32.0											
21	2.5(150)																											2050×2500	1230	820	640	905	900	111.0	69.0	58.0	92.5	36.0	55.0	91.5	41.5	33.5	17.0
22	1.0(60)	41.5	33.5	17.0	29.0																																						
23	1.5(90)	2350×1850	1250	1100	680 [690]	530	1050	1740	800	92.0	45.0	36.5	74.0	45.0	36.5	20.0	32.0																										
24	1.75(105)													45.0	36.5	20.0	32.0																										
25	2.0(120)													2500×2050	1360	1140	705 [715]	640	1110	900	111.0	69.0	58.0	92.5	36.0	55.0	91.5														42.0	33.5	17.5
26	2.5(150)	42.0	33.5	17.5	29.5																																						
27	1.0(60)	2000×2600	1140	860	1107 [1112]	530	845	1330	800	93.0	45.5	37.0	75.0															45.5	37.0	75.0	20.0	32.0											
28	1.5(90)													45.5	37.0	75.0	20.0	32.0																									
29	1.75(105)													2050×2600	1180	870	640	905	900	113.0	69.5	58.5	93.5	36.5	55.0	93.0	42.0	33.5	17.5	29.5													
30	2.0(120)																										42.0	33.5	17.5	29.5													
31	2.5(150)																										2350×2000	1250	1100	755 [765]	530	1050	1740	800	99.5	47.5	38.5	79.0	47.5	38.5	79.0	20.0	33.5
32	1.0(60)	47.5	38.5	79.0	20.0	33.5																																					
33	1.5(90)	2500×2100	1360	1140	1110	1110	1110	1740	800	99.5	44.0	35.5	71.5	44.0	35.5	71.5	17.5	30.5																									
34	1.75(105)													44.0	35.5	71.5	17.5	30.5																									
35	2.0(120)													2150×2800	1235	915	1207 [1212]	955	45	1430	800	93.0	45.5	37.0	75.0	45.5													37.0	75.0	20.0	32.0	
36	2.5(150)	45.5	37.0	75.0	20.0	32.0																																					
37	1.0(60)	2200×2800	1260	940	940	940	940	1740	800	93.0	45.5	37.0	75.0													45.5	37.0	75.0	20.0	32.0													
38	1.5(90)																									45.5	37.0	75.0	20.0	32.0													
39	1.75(105)																									2450×2150	1320	1130	830 [840]	640	1110	1740	800	99.5	47.5	38.5	79.0	47.5	38.5	79.0	20.0	33.5	
40	2.0(120)	47.5	38.5	79.0	20.0	33.5																																					
41	2.5(150)	2500×2100	1360	1140	1110	1110	1110	1740	800	99.5	47.5	38.5	79.0	47.5	38.5	79.0	20.0	33.5																									
42	1.0(60)													47.5	38.5	79.0	20.0	33.5																									
43	1.5(90)													2150×2800	1235	915	1207 [1212]	955	45	1430	800	93.0	45.5	37.0	75.0													45.5	37.0	75.0	20.0	32.0	
44	1.75(105)	45.5	37.0	75.0	20.0	32.0																																					
45	2.0(120)	2200×2800	1260	940	940	940	940	1740	800	93.0	45.5	37.0	75.0													45.5	37.0	75.0	20.0	32.0													
46	2.5(150)																									45.5	37.0	75.0	20.0	32.0													
47	1.0(60)																									2450×2150	1320	1130	830 [840]	640	1110	1740	800	99.5	47.5	38.5	79.0	47.5	38.5	79.0	20.0	33.5	
48	1.5(90)	47.5	38.5	79.0	20.0	33.5																																					
49	1.75(105)	2500×2150	1355	1145	830 [840]	640	1110	1740	800	99.5	47.5	38.5	79.0	47.5	38.5	79.0	20.0	33.5																									
50	2.0(120)													47.5	38.5	79.0	20.0	33.5																									
51	2.5(150)													2650×2050	1420	1230	730 [740]	1210	1940	1940	800	93.0	45.5	37.0	75.0													45.5	37.0	75.0	20.0	32.0	
52	1.0(60)	45.5	37.0	75.0	20.0	32.0																																					
53	1.5(90)	2700×2050	1460	1240	730 [740]	1210	1940	1940	800	93.0	45.5	37.0	75.0													45.5	37.0	75.0	20.0	32.0													
54	1.75(105)																									45.5	37.0	75.0	20.0	32.0													
55	2.0(120)																									45.5	37.0	75.0	20.0	32.0													
56	2.5(150)	45.5	37.0	75.0	20.0	32.0																																					

Notes
 - Above tables shows the dimensions on the following conditions
 (1) Single elevator in hoistway (2) Without counterweight safety
 Please consult Hitachi or local agent if other specifications are required.

*1 () : Travel distance > 60m
 *2 [] : With fire rated door
 *3 Rated speed 1.0m/s : Travel distance ≤ 60m
 Rated speed 1.5 , 1.75m/s : Travel distance ≤ 80m
 Rated speed 2.0 , 2.5m/s : Travel distance ≤ 120m
 *4 The pit reaction loading differs depending on the specifications and design, please consult Hitachi or local agent.

Based on SS550

No.	Load [kg]	Persons	Rated speed [m/s] (m/min)	Door type	Door OP width W [mm]	Car internal size A × B [mm]	Hoistway X × Y [mm]	Location [mm]									Pit reaction loading *3*4 [kN]																													
								X3			X4			C	D	E	F	RGC	RGW	Car side			Counterweight side																							
								X3	X4	C	RC1	RC2	RC3							RW1	RW2	RW3																								
57	1200	17	1.0(60)	2PCO	1100	2000×1400	2850×2000	1520	1330	680 [690]	1310	—	2140	122.5	57.0	46.0	98.0	24.5	40.5																											
58			1.5(90)												62.5	50.5		28.5	45.0																											
59			1.75(105)												2900×2050	1560		1340	705 [715]	110.0	38.0	59.5	71.5	59.0	16.0	25.5	134.5	77.0	63.5	110.0	38.0	59.5														
60			2.0(120)																									77.0	63.5	110.0	38.0	59.5														
61			2.5(150)																									37.0	30.0	16.5	26.5															
62			1.0(60)																									1300×2300	2250×2800	1315	935	102.5	28.5	46.0	1207 [1212]	1005	95	1530	128.5	59.0	47.5	102.5	25.0	41.5		
63			1.5(90)												64.0	52.0		28.5	46.0																											
64			1.75(105)												1330	920		705 [715]	530	1000	1640	800	90.5	41.0	33.0	72.5	19.5													31.5	73.5		38.0	33.5	21.0	28.5
65			2.0(120)																																								38.0	33.5	21.0	28.5
66			2.5(150)																																								41.0	36.5	24.0	31.5
67	1.0(60)	1350	20	2PCO	1000	1800×1750	2650×2200	1420	1230	855 [865]	1210	—	1940	66.25x2sets	60.5	48.5	105.0	25.0	42.5																											
68	1.5(90)														60.5	48.5		25.0	42.5																											
69	1.75(105)														2700×2200	1460		1240	640	1060	900	108.5	68.0	57.0	90.0	36.0	54.5	91.5	38.0	33.5	21.0	28.5														
70	2.0(120)																												38.0	33.5	21.0	28.5														
71	2.5(150)																												41.0	36.5	24.0	31.5														
72	1.0(60)														2000×1550	2850×2100		1520	1330	105.0	29.0	46.5	765 [765]	1310	—	2140	132.5	65.5	53.0	105.0	29.0	46.5														
73	1.5(90)																											65.5	53.0		29.0	46.5														
74	1.75(105)																											2900×2100	1560		1340	705 [715]	640	1110	900	108.5	68.0	57.0	90.0	36.0	54.5	91.5	41.0	36.5	24.0	31.5
75	2.0(120)																																										41.0	36.5	24.0	31.5
76	2.5(150)																																										2850×2100	1560	1340	705 [715]
77	1.0(60)	41.0	36.5	24.0	31.5																																									
78	1.5(90)	1400×2400	2350×2900	1365	985	114.0	26.0	44.5	1257 [1262]	1055	95	1630	144.0	69.0	56.0	114.0	29.5	48.5																												
79	1.75(105)													69.0	56.0		29.5	48.5																												
80	2.0(120)													2850×2100	1560		1340	705 [715]	640	1110	900	108.5	68.0	57.0	90.0	36.0	54.5	91.5	41.0	36.5	24.0	31.5														
81	2.5(150)	41.0	36.5	24.0	31.5																																									
82	1.0(60)	2000×1750	2850×2200	1520	1330	118.5	28.0	44.5	7																																					

Overhead Height and Pit Depth

Hoistway section

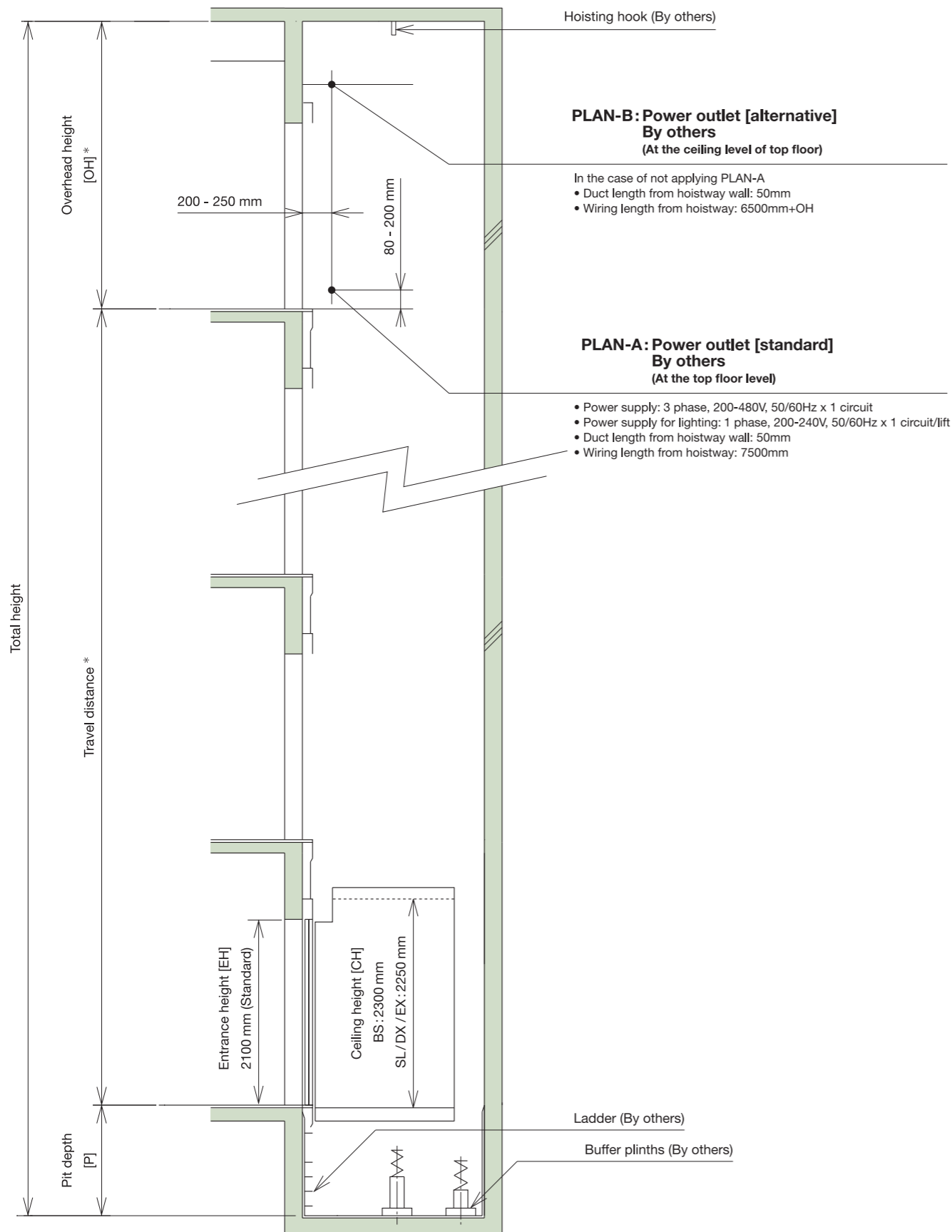

* If total number of floors is 2, please consult Hitachi or local agent about minimum travel distance and overhead height.

Dimensions for overhead height, pit depth and other specifications

Standard overhead height : OH *1 *2 *3 [mm]

No.	Rated speed [m/s] (m/min)	Hitachi standard Hitachi standard for India			EN81-20/50 SASO-EN81-20/50			Malaysian regulations		
		Load ≤ 1050kg	Load ≥ 1150kg	Load > 1600kg	Load ≤ 1050kg	Load ≥ 1150kg	Load > 1600kg	Load ≤ 1050kg	Load ≥ 1150kg	Load > 1635kg
1	1.0(60)	3750 (3870)	4150 (4270)	4300 (4420)	4150 (4270)	4250 (4370)	4300 (4420)	4200(4320)	4300(4420)	4350(4470)
2	1.5(90)							4400(4520)	4400(4520)	4400(4520)
3	1.75(105)	4050(4170)	4350(4470)	4350(4470)	4350(4470)	4350(4470)	4350(4470)	4450(4570)	4450(4570)	4450(4570)
4	2.0(120)	4600(4600)	4600(4600)	—	4600(4600)	4600(4600)	—	5600(5720)	5600(5720)	—
5	2.5(150)	4700(4700)	4700(4700)	—	4700(4700)	4700(4700)	—	5750(5870)	5750(5870)	—

No.	Rated speed [m/s] (m/min)	SS550		
		Load ≤ 1050kg	Load ≥ 1150kg	Load > 1630kg
1	1.0(60)	3950(4070)	4150(4270)	4300(4420)
2	1.5(90)	4150(4270)	4400(4520)	4400(4520)
3	1.75(105)	4300(4420)	4500(4620)	4500(4620)
4	2.0(120)	5500(5620)	5500(5620)	—
5	2.5(150)	5650(5770)	5650(5770)	—

Minimum pit depth : P *4 [mm]

No.	Rated speed [m/s] (m/min)	Hitachi standard Hitachi standard for India EN81-20/50 SASO-EN81-20/50			Malaysian regulations			SS550		
		Load ≤ 1050kg	Load ≥ 1150kg	Load > 1600kg	Load ≤ 1050kg	Load ≥ 1150kg	Load > 1635kg	Load ≤ 1050kg	Load ≥ 1150kg	Load > 1630kg
1	1.0(60)				1500	1750	1750	1500	1750	1900
2	1.5(90)	1350	1600	1650	1600	1850	1900	1600	1900	2050
3	1.75(105)	1450	1700	1800	1650	1950	2000	1650	2100	2250
4	2.0(120)	2000	2300	—	2050(2000)	2300	—	2050(2000)	2300	—
5	2.5(150)	2050	2350	—	2150(2050)	2350	—	2200(2050)	2350	—

Others

No.	Rated speed [m/s] (m/min)	Maximum number of stops	Maximum travel distance [m]
1	1.0(60)	24	60
2	1.5(90)	32	80
3	1.75(105)		
4	2.0(120)	36	120
5	2.5(150)		

Notes
- Above tables shows the dimensions based on standard specifications.
Please consult Hitachi or local agent if other specifications are required.

Rated Speed 1.75m/s or less

- *1 (): SL/DX/EX series ceiling
- *2 Travel distance ≤ 30m
30m < Travel distance ≤ 60m : Above overhead height + 50mm
60m < Travel distance ≤ 80m : Above overhead height + 100mm
- *3 Overhead height will be increased accordingly if either EH or CH increases.
- *4 Travel distance ≤ 45m
LOAD ≤ 1050kg 45m < Travel distance ≤ 60m : Above pit depth + 50mm
60m < Travel distance : Above pit depth + 200mm
LOAD ≥ 1150kg 45m < Travel distance : Above pit depth + 50mm

Rated Speed 2.0m/s or 2.5m/s

- *1 (): SL/DX/EX series ceiling
- *2 30m ≤ Travel distance ≤ 45m
45m < Travel distance ≤ 80m : Above overhead height + 50mm
80m < Travel distance ≤ 120m : Above overhead height + 100mm
- *3 Overhead height will be increased accordingly if either EH or CH increases.
- *4 For SS550 and Malaysian regulations, (): Travel distance ≤ 60m

Location of hoisting hook and hoisting beam

If the hoistway is made of reinforced concrete, hoisting hooks (installed by other contractors) are required at the top of the hoistway. If the hoistway is a steel structure, hoisting beams (installed by other contractors) are required at the top of the hoistway. The details of the hoisting hook and hoisting beam mounting position are as follows:

① Hoisting hooks

1. Rated Load ≤ 1050kg

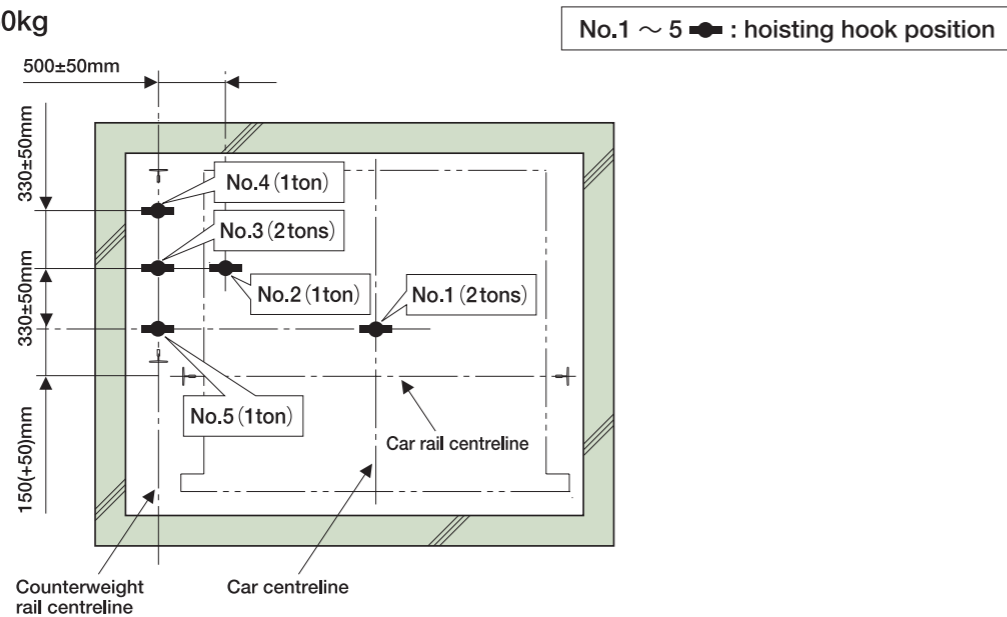

2. Rated Load > 1050kg

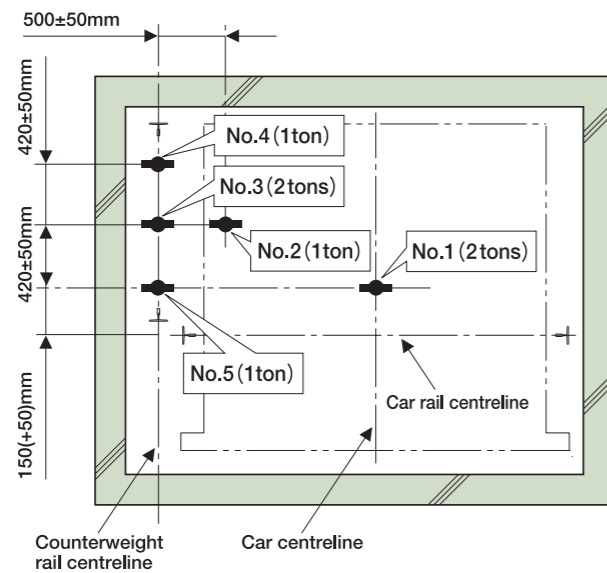

3. Orientation and size of Hoisting Hooks

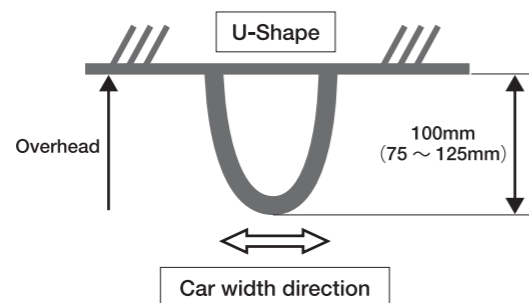

Notes
 - The hoisting hooks should be orientated such that the U-shape is facing the hoistway landing entrance.
 - This hoisting hook size is required to ensure that the hoisting equipment can fit in.

② Hoisting beams

1. Hoisting beams layout (Standard)

Hoisting beams in the direction of car depth

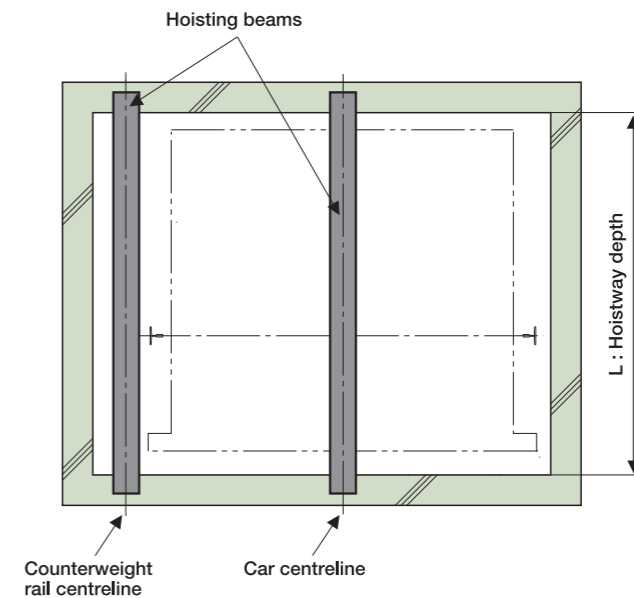

2. Hoisting beams layout (Alternative)

Hoisting beams in the direction of car width

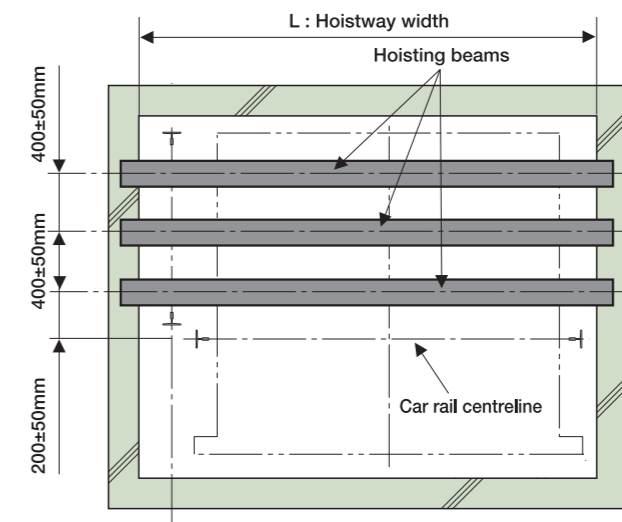

3. Height of Hoisting beams

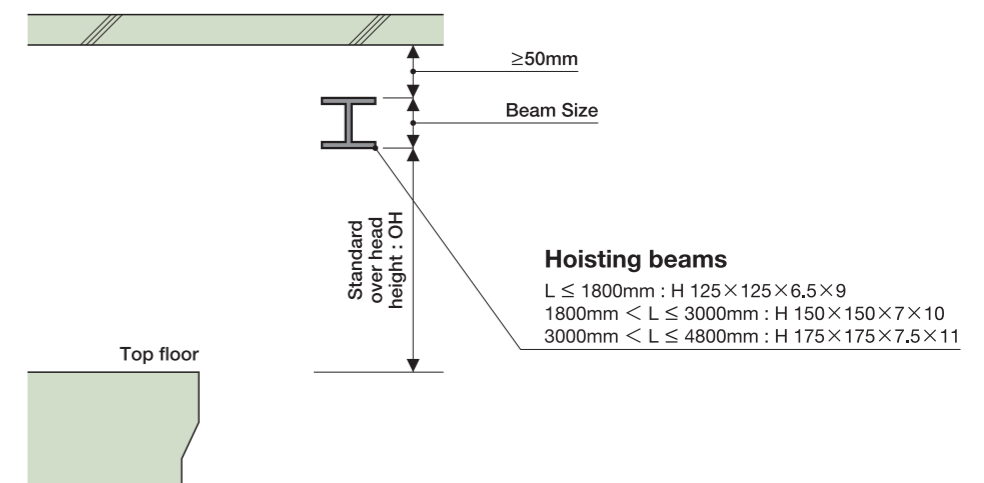

Electrical information

Required capacity of circuit breaker, transformer & starting power at building side

Electrical Data

No.	Load [kg]	Rated speed [m/s] (m/min)	Motor capacity [kW]	Supply voltage [V]	Breaker capacity [A]			Transformer capacity [kVA]			Starting power [kVA]	Lead-in wire for drive [mm ²]			Earth wire [mm ²]	Calorific value [kcal/hr]	
					1 unit	2 units	3 units	1 unit	2 units	3 units		1 unit	2 units	3 units			
1	451 ~ 630	1.0(60)	3.9	220-230	100	125	150	5	9	12	15	22.0	38	60	3.5	830	
2				380-415	20	30	30					5.5	14	14			2.0
3				440-480	50	75	100					8	14	2.0			
4		1.5(90)	5.8	220-230	100	125	150	6	11	15	20	22.0	60		60		3.5
5				380-415	30	30	40					8.0	22	2.0			
6				440-480	50	75	100					5.5	14		2.0		
7		1.75(105)	6.8	220-230	100	125	150	7	12	17	23	38.0	60	100			3.5
8				380-415	30	40	50					8.0	22	2.0			
9				440-480	50	75	100					5.5	14		2.0		
10	631 ~ 750	1.0(60)	4.6	220-230	100	125	150	5	9	12	16	22.0	38	60		3.5	
11				380-415	20	30	40					5.5	14	14	2.0		
12				440-480	50	75	100					8	14	22			2.0
13		1.5(90)	6.9	220-230	100	125	150	7	12	17	23	38.0	60	100	3.5		
14				380-415	30	40	50					8.0	22	2.0			
15				440-480	50	75	100					5.5	14			2.0	
16		1.75(105)	8.1	220-230	100	125	150	7	12	17	26	38.0	60	100	3.5		
17				380-415	40	40	50					14.0	22	3.5			
18				440-480	50	75	100					8.0	14			3.5	
19	748 ~ 750	2.0(120)	11.0	220-230	175	200	250	14	26	36	44	60.0	150	150(114m)*1	5.5		
20				380-415	40	50	75					22.0	38	60		3.5	
21				440-480	100	100	150					14.0	22	38			3.5
22		2.5(150)	13.0	220-230	175	200	250	16	30	41	50	100.0	150(138m)*1	150(98m)*1	5.5		
23				380-415	50	60	100					22.0	38	60		3.5	
24				440-480	100	100	150					14.0	38	38			3.5
25		751 ~ 900	1.0(60)	5.6	220-230	100	125	150	6	11	15	19	22.0	60	60	2.0	
26					380-415	30	30	40					8.0	22	22		2.0
27					440-480	50	75	100					5.5	14	14		
28	1.5(90)		8.3	220-230	100	125	150	8	14	19	27	38.0	60	100	3.5		
29				380-415	40	40	50					14.0	22	38		3.5	
30				440-480	50	75	100					8.0	14	22			3.5
31	1.75(105)		9.7	220-230	100	125	150	10	17	24	30	38.0	100	150	5.5		
32				380-415	40	40	60					14.0	22	38		3.5	
33				440-480	50	75	100					8.0	14	22			3.5
34	2.0(120)	12.0	220-230	175	200	250	15	28	39	47	100.0	150(148m)*1	150(106m)*1	5.5			
35			380-415	50	60	75					22.0	38	60		3.5		
36			440-480	100	100	150					14.0	38	38			3.5	
37	2.5(150)	15.0	220-230	175	200	250	18	33	46	57	100.0	150(121m)*1	150(86m)*1	5.5			
38			380-415	50	75	100					22.0	60	60		3.5		
39			440-480	100	100	150					38.0	60	100			3.5	
40	901 ~ 1050	1.0(60)	6.5	220-230	100	125	150	7	12	17	22	38.0	60	100	2.0		
41				380-415	30	40	40					8.0	22	22		2.0	
42				440-480	50	75	100					5.5	14	14			2.0
43		1.5(90)	9.7	220-230	100	125	150	9	16	22	30	38.0	100	150	5.5		
44				380-415	40	40	60					14.0	22	38		3.5	
45				440-480	50	75	100					8.0	14	22			3.5
46		1.75(105)	11.7	220-230	100	125	150	10	17	24	36	60.0	100	150	5.5		
47				380-415	40	50	75					14.0	38	38		3.5	
48				440-480	50	75	100					22.0	60	100			3.5
49	2.0(120)	13.0	220-230	175	200	250	16	30	41	50	100.0	150(138m)*1	150(98m)*1	5.5			
50			380-415	50	60	100					22.0	38	60		3.5		
51			440-480	100	100	150					14.0	38	38			3.5	
52	2.5(150)	17.0	220-230	175	200	250	20	37	51	64	100.0	150(108m)*1	150(77m)*1	5.5			
53			380-415	60	75	100					38.0	60	100		3.5		
54			440-480	100	100	150					22.0	38	60			3.5	
55	1.0(60)	7.1	220-230	100	125	150	7	12	17	23	38.0	60	100	3.5			
56			380-415	40	40	50					8.0	14	22		2.0		
57			440-480	50	75	100					5.5	14	22			2.0	
58	1.5(90)	11.0	220-230	100	125	150	10	17	24	34	60.0	100	150	5.5			
59			380-415	40	50	75					14.0	22	38		3.5		
60			440-480	50	75	100					8.0	14	22			3.5	

Notes
 - Maximum length of lead-in wire is 150m, maximum lead-in wire size is 150mm².
 *1 (): Maximum length of lead-in wire with 150mm².
 *2 Please consult Hitachi or local agent about maximum size and maximum length of lead-in wire.

Electrical Data

No.	Load [kg]	Rated speed [m/s] (m/min)	Motor capacity [kW]	Supply voltage [V]	Breaker capacity [A]			Transformer capacity [kVA]			Starting power [kVA]	Lead-in wire for drive [mm ²]			Earth wire [mm ²]	Calorific value [kcal/hr]
					1 unit	2 units	3 units	1 unit	2 units	3 units		1 unit	2 units	3 units		
61	1051 ~ 1150	1.75(105)	13	220-230	100	125	150	11	19	26	40	60	100	150(146m)*1	5.5	
62				380-415	50	60	75					14	38	38		3.5
63				440-480	75	100	22					38	38	3.5		
64		2.0(120)	15	220-230	175	200	250	18	33	46	57	100	150(121m)*1		150(86m)*1	5.5
65				380-415	50	75	100					22	60	60	3.5	
66				440-480	100	100	150					5.5	38	60		
67		2.5(150)	18	220-230	175	200	250	21	39	54	68	150	150(102m)*1	150(73m)*1	5.5	
68				380-415	60	75	125					38	60	100		3.5
69				440-480	100	100	150					22	38	60		
70	1151 ~ 1350	1.0(60)	8.3	220-230	100	125	150	8	14	19	27	38	60	100	3.5	
71				380-415	40	40	50					14	22	38		3.5
72				440-480	50	75	100					8	14	22		
73		1.5(90)	13	220-230	100	125	150	11	19	26	40	60	100	150(146m)*1	5.5	
74				380-415	50	60	75					14	38	38		3.5
75				440-480	75	100	22					38	38	3.5		
76		1.75(105)	15	220-230	100	125	150	12	21	29	45	60	150		150(128m)*1	5.5
77				380-415	50	60	100					22	38	60	3.5	
78				440-480	75	100	22					38	38	3.5		
79	2.0(120)	17	220-230	175	200	250	20	37	51	64	100	150(108m)*1	150(77m)*1		5.5	
80			380-415	60	75	100					38	60	100	3.5		
81			440-480	100	100	150					22	38	60			3.5
82	2.5(150)	21	220-230	175	200	250	25	46	64	78	150	150(88m)*1	150(63m)*1	5.5		
83			380-415	60	100	125					38	60	100		3.5	
84			440-480	100	100	150					22	60	100			3.5
85	1351 ~ 1635	1.0(60)	10	220-230	100	125	150	9	16	22	31	38	100	150	3.5	
86				380-415	40	50	60					14	22	38		3.5
87				440-480	50	75	100					8	14	22		
88		1.5(90)	15	220-230	100	125	150	12	21	29	45	60	150	150(128m)*1	5.5	
89				380-415	50	60	100					22	38	60		3.5
90				440-480	75	100	22					38	38	3.5		
91		1.75(105)	18	220-230	100	125	150	15	26	36	53	100	150		150(109m)*1	5.5
92				380-415	60	75	100					22	38	60	3.5	
93				440-480	50	75	100					14	24	33		
94	2.0(120)	20	220-230	175	200	250	25	46	64	78	150	150(88m)*1	150(63m)*1	5.5		
95			380-415	60	100	125					38	60	100		3.5	
96			440-480	100	100	150					22	60	100			3.5
97	2.5(150)	25	220-230	175	200	250	30	55	77	95	150(131m)*1	150(72m)*1	*			

Memo
